

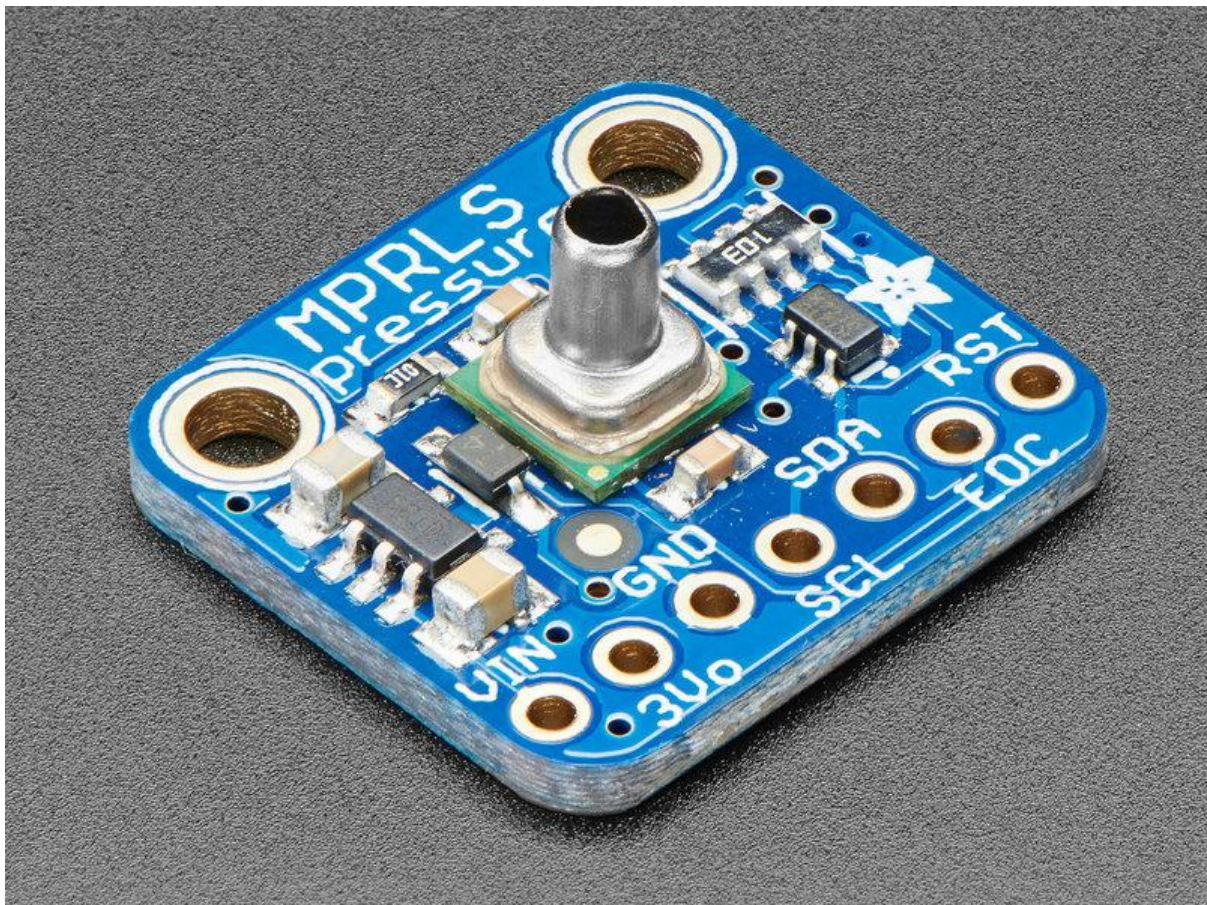

Adafruit MPRLS Ported Pressure Sensor Breakout

Created by lady ada



<https://learn.adafruit.com/adafruit-mprls-ported-pressure-sensor-breakout>

Last updated on 2021-11-15 07:22:05 PM EST

Table of Contents

Overview	3
Pinouts	5
• Power Pins:	6
• I2C Logic pins:	6
• Other pins:	6
Assembly	7
• Prepare the header strip:	7
• Add the breakout board:	8
• And Solder!	8
Arduino Test	10
• Install Arduino Libraries	10
• Basic Example	11
Arduino Library Docs	12
Python & CircuitPython	12
• CircuitPython Microcontroller Wiring	12
• Python Computer Wiring	13
• CircuitPython Installation of MPRLS Library	13
• Python Installation of MPRLS Library	14
• CircuitPython & Python Usage	14
• Full Example Code	15
Python Docs	16
Downloads	16
• Datasheets & Files	16
• Schematic & Fabrication Print	16

Overview

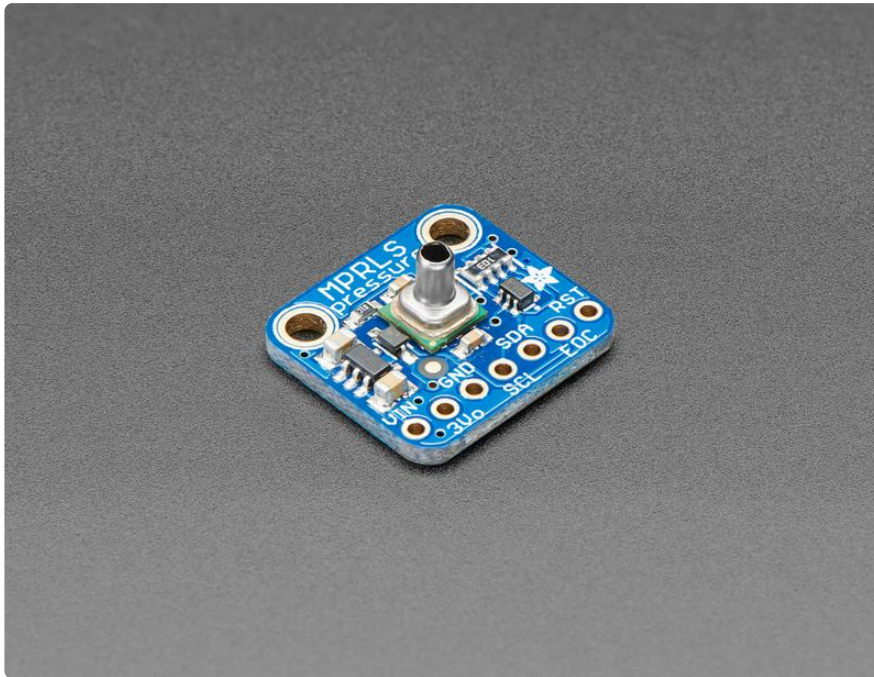

We stock a few barometric pressure sensors, great for altitude and weather measurements. This pressure sensor is special because it comes with a metal port! Unlike other pressure sensors, you can easily attach a tube to it, to measure air pressure inside a close space. In particular we think this would be a great sensor for use with making DIY assistive tech "Sip & Puff" interfaces, or measuring the pressure within a vacuum chamber or other pressurized container.

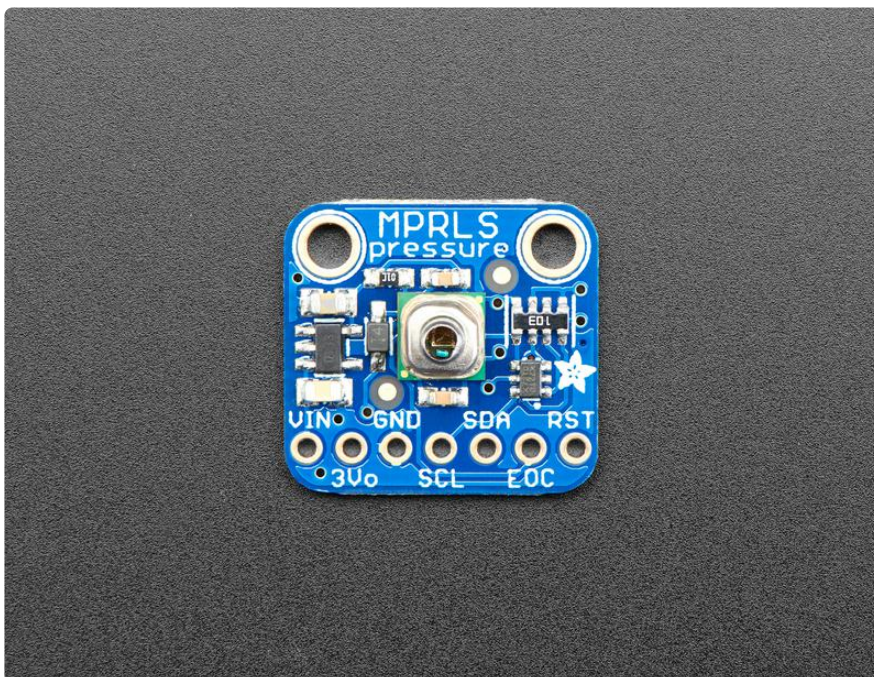

Unlike most ported pressure sensors, this one uses I2C, it's really easy to use with any microcontroller. Inside is a silicone-gel covered pressure sensing gauge with a pre-calibrated and compensated 24 bit ADC. We have [example code and libraries for Arduino](https://adafru.it/CCe) (<https://adafru.it/CCe>) or [CircuitPython/Python](https://adafru.it/CCf) (<https://adafru.it/CCf>). You can measure absolute pressure 0 to 25 PSI, which is a great range since ambient pressure here on Earth is about 14.5 PSI.

The port is made of stainless steel and is 3.7mm long and 2.5mm diameter. It doesn't come with tubing so be sure to purchase some tubing to attach to the port. Consider using 3/32" ID (internal diameter) tubing. If you find it's not snug enough for your project, try using 1/4" ID tubing with the 3/32" ID tubing inside for a better fit.

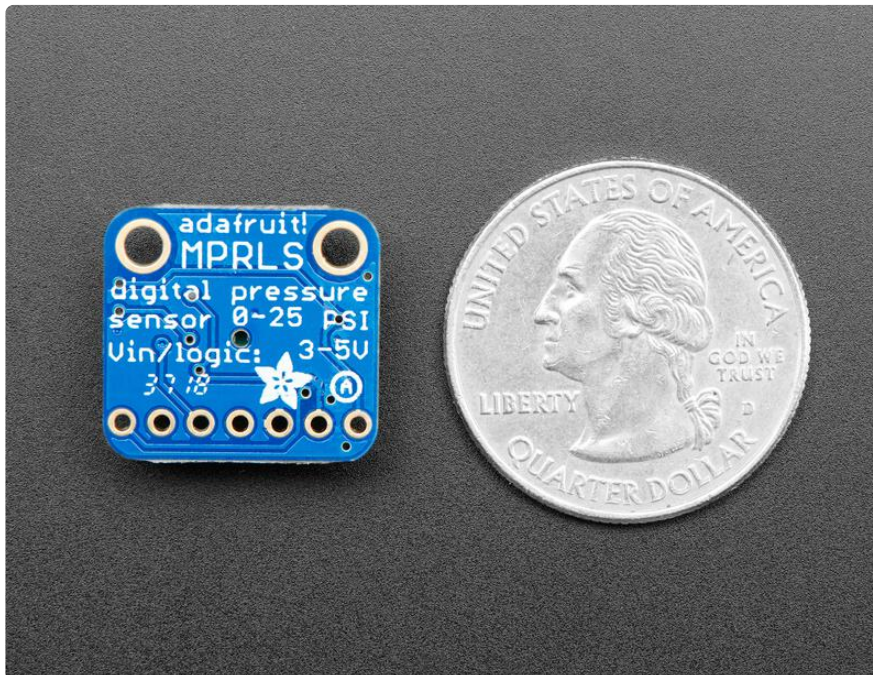

We've placed this nice sensor on a breakout board with 3.3V power regulation and level shifting so you can use it with any kind of microcontroller or microcomputer, from an Arduino compatible to Raspberry Pi

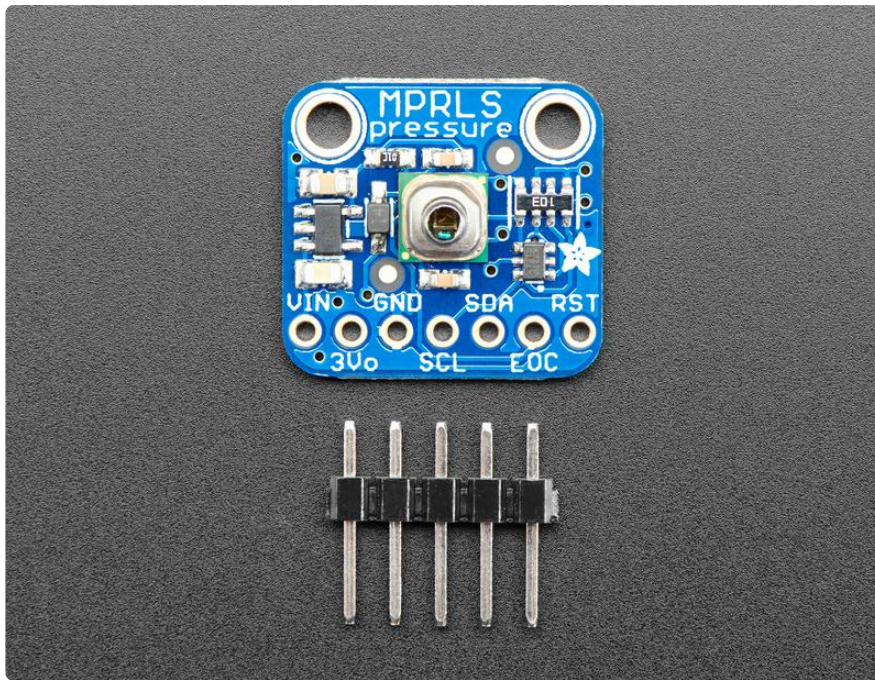

Pinouts

The MPRLS is a I2C sensor. That means it uses the two I2C data/clock wires available on most microcontrollers, and can share those pins with other sensors as long as they don't have an address collision. For future reference, the I2C address is 0x18 and you can't change it!

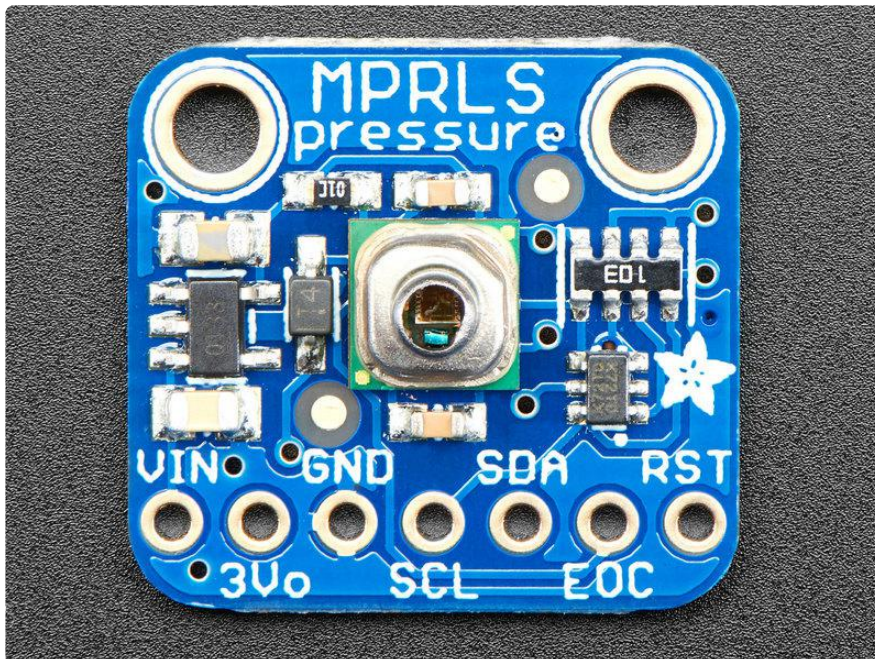

Power Pins:

- Vin - this is the power pin. Since the chip uses 3 VDC, we have included a voltage regulator on board that will take 3-5VDC and safely convert it down. To power the board, give it the same power as the logic level of your microcontroller - e.g. for a 5V micro like Arduino, use 5V
- 3v3 - this is the 3.3V output from the voltage regulator, you can grab up to 100mA from this if you like
- GND - common ground for power and logic

I2C Logic pins:

- SCL - I2C clock pin, connect to your microcontrollers I2C clock line.
- SDA - I2C data pin, connect to your microcontrollers I2C data line.

Other pins:

- RST - Hardware reset input pin. Pulled up by default, drive to ground to hardware reset the board. 3-5V logic safe
- EOC - End Of Conversion output pin. Will toggle to let you know a sensing conversion is ready to be read. Optional but will speed up you interface code just a bit. You can leave it disconnected and we'll query the chip over I2C for when it's ready.

Assembly

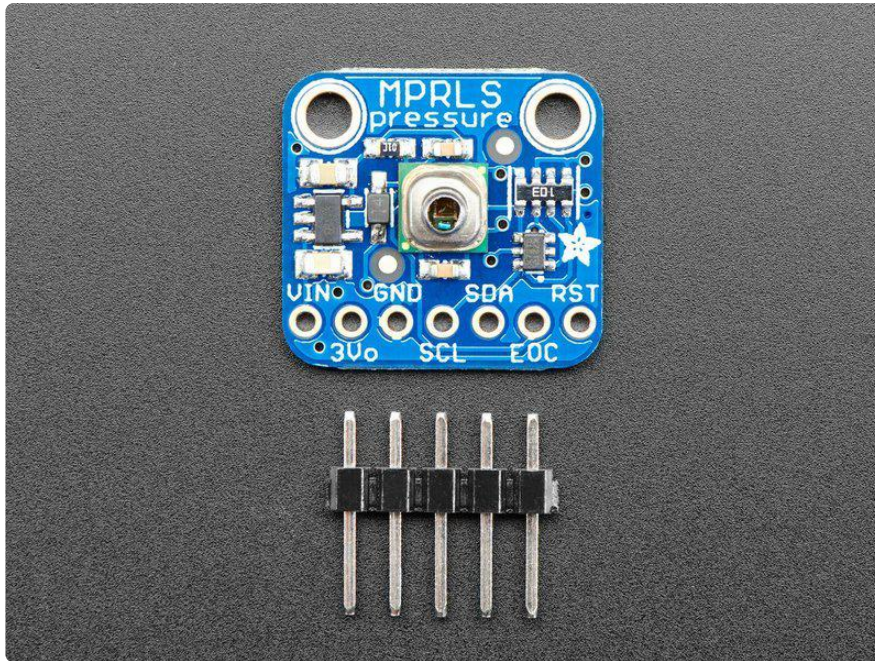

Prepare the header strip:

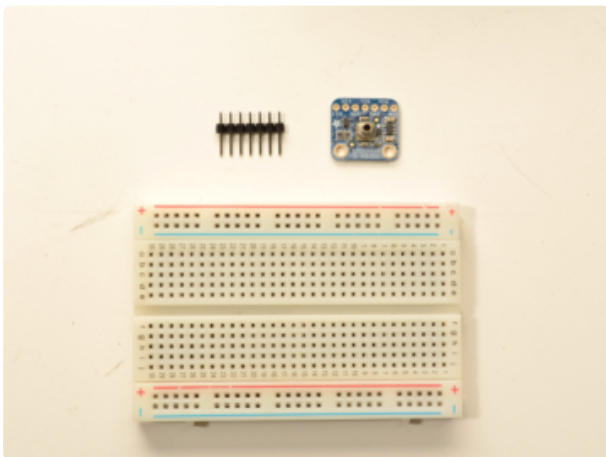

Cut the strip to length if necessary. It will be easier to solder if you insert it into a breadboard - long pins down

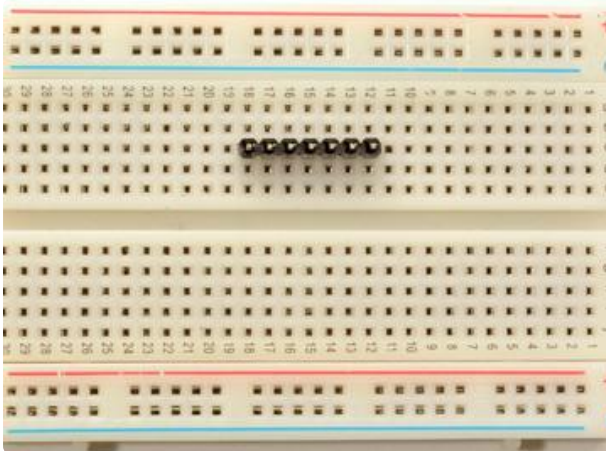

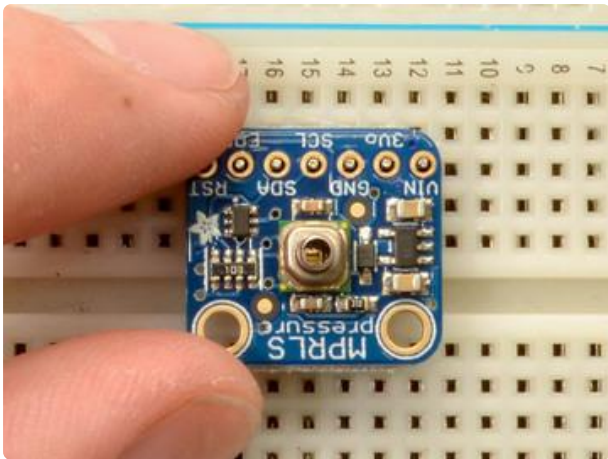

Add the breakout board:

Place the breakout board over the pins so that the short pins poke through the breakout pads

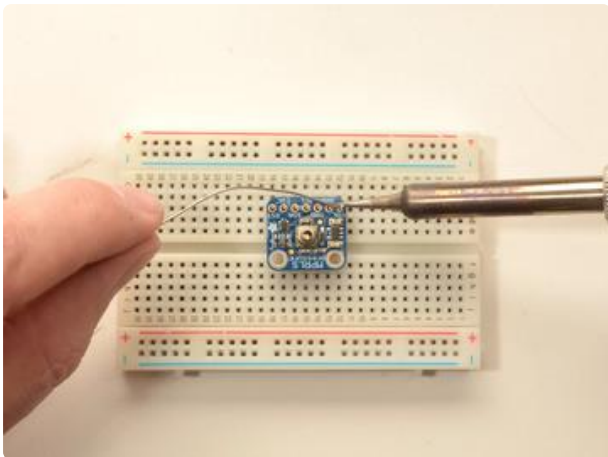

And Solder!

Be sure to solder all pins for reliable electrical contact.

(For tips on soldering, be sure to check out our [Guide to Excellent Soldering \(https://adafru.it/aTk\)](https://adafru.it/aTk)).

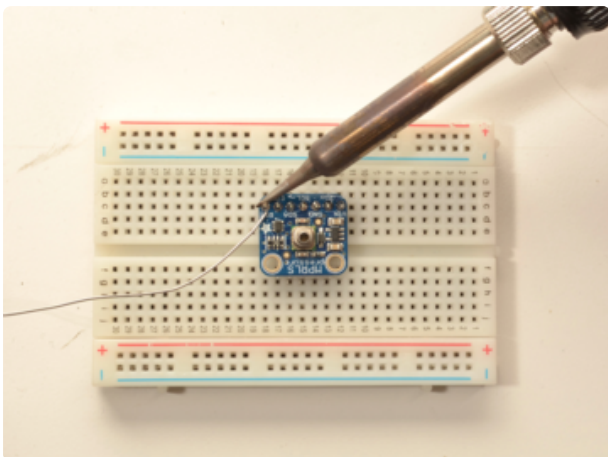
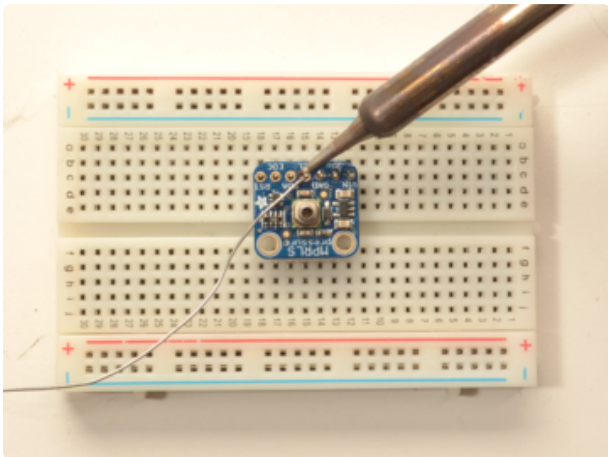

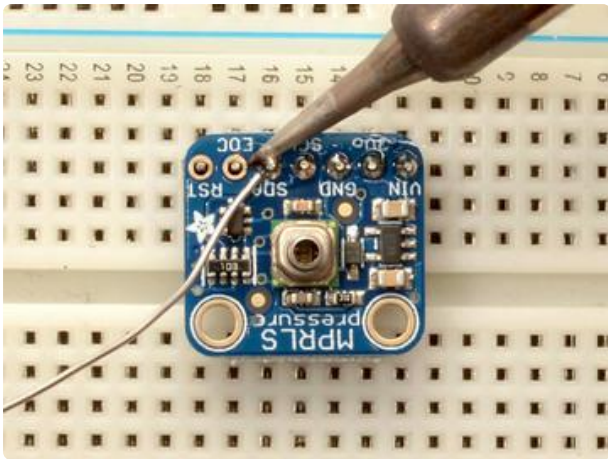

You're done! Check your solder joints visually and continue onto the next steps.

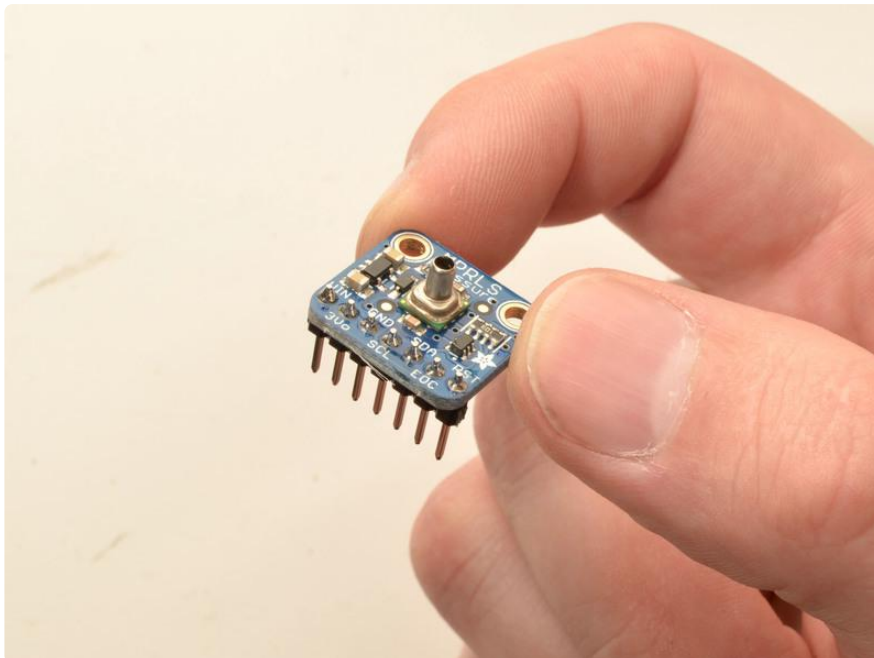
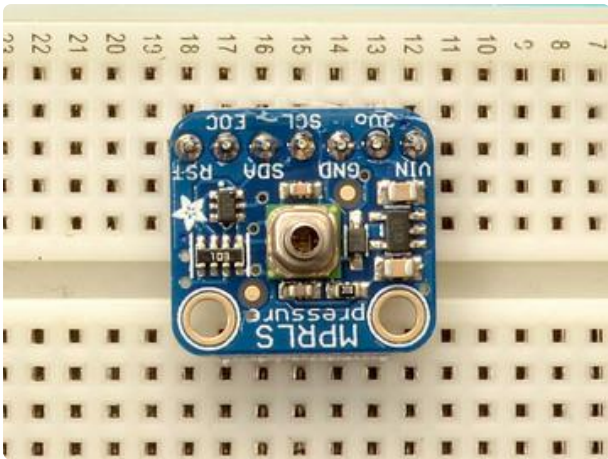

Arduino Test

You can easily wire this breakout to any microcontroller, we'll be using an Arduino. For another kind of microcontroller, just make sure it has I2C, then port the code - its pretty simple stuff!

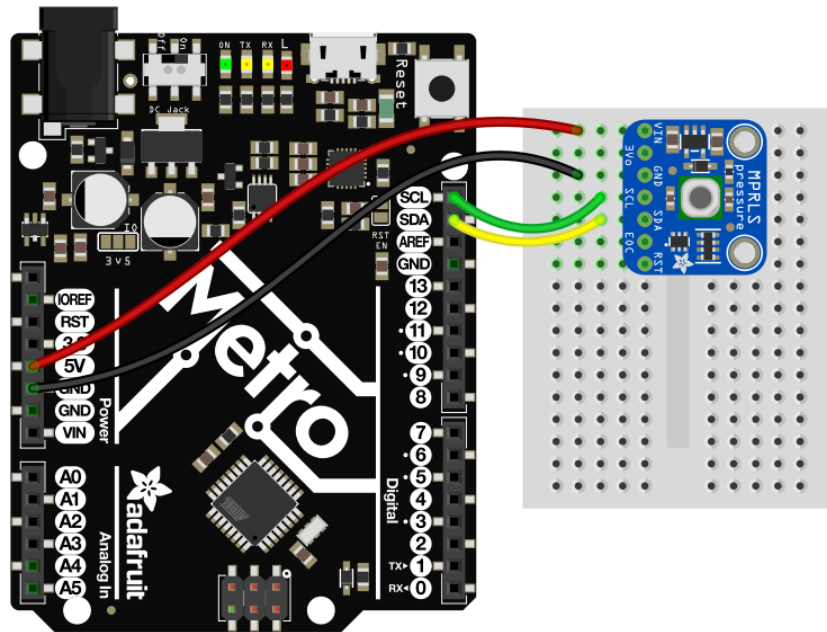

- Connect Vin to the power supply, 3-5V is fine. Use the same voltage that the microcontroller logic is based off of. For most Arduinos, that is 5V
- Connect GND to common power/data ground
- Connect the SCL pin to the I2C clock SCL pin on your Arduino. On an UNO & '328 based Arduino, this is also known as A5, on a Mega it is also known as digital 21 and on a Leonardo/Micro, digital 3
- Connect the SDA pin to the I2C data SDA pin on your Arduino. On an UNO & '328 based Arduino, this is also known as A4, on a Mega it is also known as digital 20 and on a Leonardo/Micro, digital 2

The MPRLS has a default I2C address of 0x18 and cannot be changed!

Install Arduino Libraries

Lets begin by installing all the libraries we need. Open up the library manager in Arduino IDE

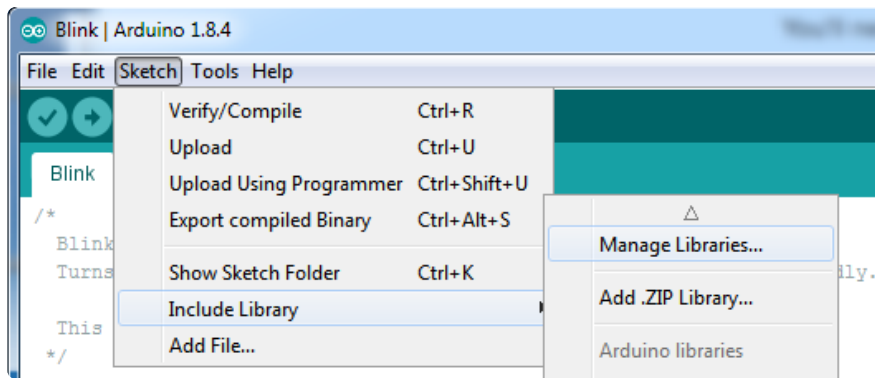

Search for and install the latest version of the Adafruit MPRLS library

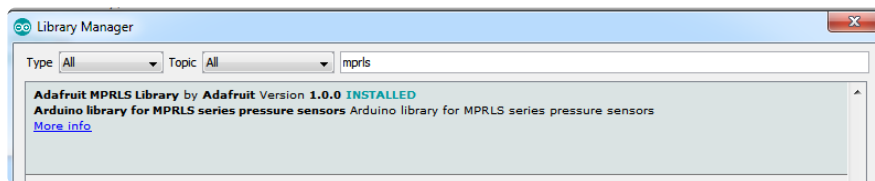

Basic Example

Start by opening up the Adafruit MPRLS -> simplestest under the Adafruit MPRLS library:

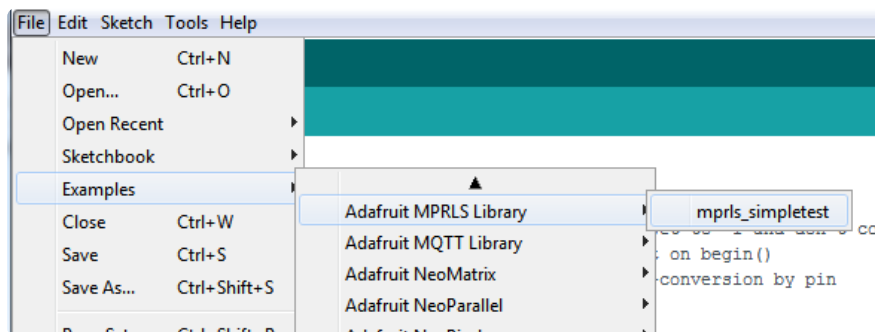

And upload it to your board!

Open up the serial console to see the readings. You can blow into the port or cover it with your finger to change the readings

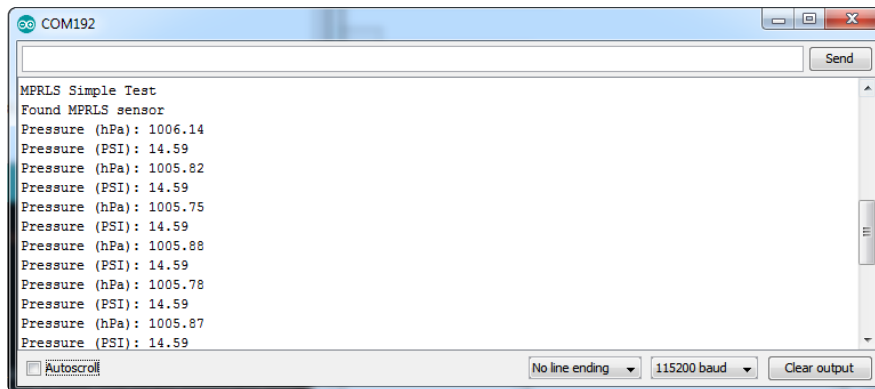

If you'd like to add hardware reset and EOC pin support, you can change these lines and update your wiring to include the wires you've selected - you can use any 2 digital pins

```
// You dont *need* a reset and EOC pin for most uses, so we set to -1 and don't connect
#define RESET_PIN -1 // set to any GPIO pin # to hard-reset on begin()
#define EOC_PIN -1 // set to any GPIO pin to read end-of-conversion by pin
Adafruit_MPRLS mpr = Adafruit_MPRLS(RESET_PIN, EOC_PIN);
```

Arduino Library Docs

[Arduino Library Docs \(https://adafru.it/CCg\)](https://adafru.it/CCg)

Python & CircuitPython

It's easy to use the MPRLS sensor with Python or CircuitPython and the [Adafruit CircuitPython MPRLS \(https://adafru.it/CCf\)](https://adafru.it/CCf) module. This module allows you to easily write Python code that reads the pressure from the sensor.

You can use this sensor with any CircuitPython microcontroller board or with a computer that has GPIO and Python [thanks to Adafruit_Blinka, our CircuitPython-for-Python compatibility library \(https://adafru.it/BSN\)](https://adafru.it/BSN).

CircuitPython Microcontroller Wiring

First wire up an MPRLS to your board exactly as shown on the previous pages for Arduino. You can use I2C. Here's an example of wiring a Feather M0 to the sensor with I2C:

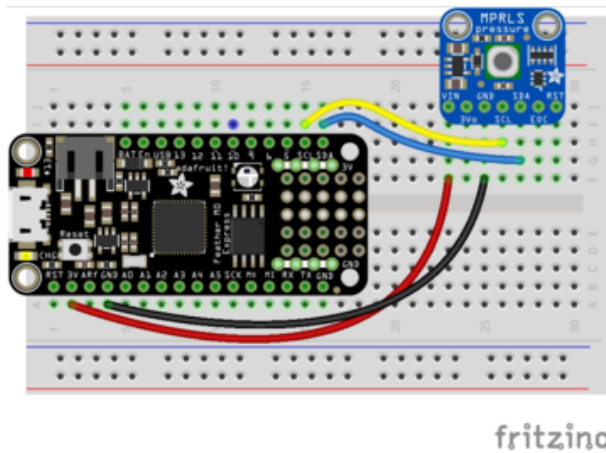

- Board 3V to sensor VIN
- Board GND to sensor GND
- Board SCL to sensor SCL
- Board SDA to sensor SDA

Python Computer Wiring

Since there's dozens of Linux computers/boards you can use we will show wiring for Raspberry Pi. For other platforms, [please visit the guide for CircuitPython on Linux to see whether your platform is supported \(https://adafru.it/BSN\)](https://adafru.it/BSN).

Here's the Raspberry Pi wired with I2C:

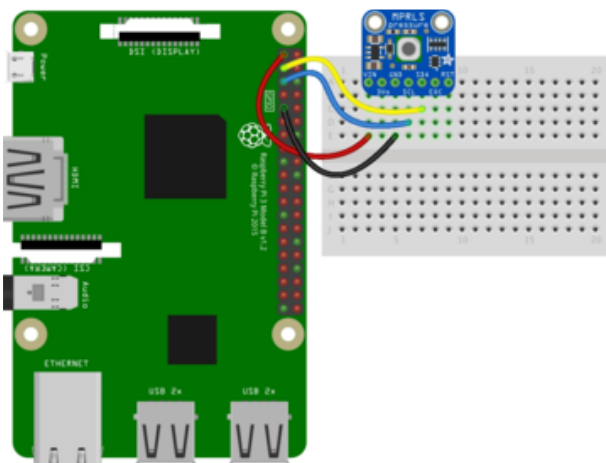

- Pi 3V3 to sensor VIN
- Pi GND to sensor GND
- Pi SCL to sensor SCL
- Pi SDA to sensor SDA

CircuitPython Installation of MPRLS Library

You'll need to install the [Adafruit CircuitPython MPRLS \(https://adafru.it/CCf\)](https://adafru.it/CCf) library on your CircuitPython board.

First make sure you are running the [latest version of Adafruit CircuitPython \(https://adafru.it/Amd\)](https://adafru.it/Amd) for your board.

Next you'll need to install the necessary libraries to use the hardware--carefully follow the steps to find and install these libraries from [Adafruit's CircuitPython library bundle \(https://adafru.it/uap\)](https://adafru.it/uap). Our CircuitPython starter guide has [a great page on how to install the library bundle \(https://adafru.it/ABU\)](https://adafru.it/ABU).

For non-express boards like the Trinket M0 or Gemma M0, you'll need to manually install the necessary libraries from the bundle:

- adafruit_mprls.mpy
- adafruit_bus_device

Before continuing make sure your board's lib folder or root filesystem has the adafruit_mprls.mpy, and adafruit_bus_device files and folders copied over.

Next [connect to the board's serial REPL \(https://adafru.it/Awz\)](https://adafru.it/Awz) so you are at the CircuitPython >>> prompt.

Python Installation of MPRLS Library

You'll need to install the Adafruit_Blinka library that provides the CircuitPython support in Python. This may also require enabling I2C on your platform and verifying you are running Python 3. [Since each platform is a little different, and Linux changes often, please visit the CircuitPython on Linux guide to get your computer ready \(https://adafru.it/BSN\)](https://adafru.it/BSN)!

Once that's done, from your command line run the following command:

- `sudo pip3 install adafruit-circuitpython-mprls`

If your default Python is version 3 you may need to run 'pip' instead. Just make sure you aren't trying to use CircuitPython on Python 2.x, it isn't supported!

CircuitPython & Python Usage

To demonstrate the usage of the sensor we'll initialize it and read the pressure from the board's Python REPL.

Since you're using an I2C connection run the following code to import the necessary modules and initialize the I2C connection with the sensor:

```
import time
import board
import busio
import adafruit_mprls
i2c = busio.I2C(board.SCL, board.SDA)
mpr = adafruit_mprls.MPRLS(i2c, psi_min=0, psi_max=25)
```

Now you're ready to read values from the sensor using any of these properties:

- `pressure` - The measured pressure, in hPa.

For example to print the pressure:

```
print("Pressure (hPa):", mpr.pressure)
```

```
>>> print("Pressure (hPa):", mpr.pressure)
Pressure (hPa): 987.021
```

That's all there is to using the MPRLS sensor with CircuitPython!

Full Example Code

```
# SPDX-FileCopyrightText: 2021 ladyada for Adafruit Industries
# SPDX-License-Identifier: MIT

import time
import board
import adafruit_mprls

i2c = board.I2C()

# Simplest use, connect to default over I2C
mpr = adafruit_mprls.MPRLS(i2c, psi_min=0, psi_max=25)

# You can also specify both reset and eoc pins
"""
import digitalio
reset = digitalio.DigitalInOut(board.D5)
eoc = digitalio.DigitalInOut(board.D6)
mpr = adafruit_mprls.MPRLS(i2c, eoc_pin=eoc, reset_pin=reset,
                           psi_min=0, psi_max=25)
"""

while True:
    print((mpr.pressure,))
    time.sleep(1)
```

Python Docs

[Python Docs \(https://adafru.it/CFy\)](https://adafru.it/CFy)

Downloads

Datasheets & Files

- [Datasheets & App notes for Honeywell MPR series \(https://adafru.it/CCh\)](https://adafru.it/CCh)
- [PCB CAD files in GitHub \(https://adafru.it/CCi\)](https://adafru.it/CCi)
- [Fritzing object in Adafruit Fritzing library \(https://adafru.it/aP3\)](https://adafru.it/aP3)

Schematic & Fabrication Print

