



Features

- Fixed 3.3V \pm 4% Output
- VIN Range: 1.8V to 5V
- Output Current: Up to 150mA
- Constant Frequency Operation at All Loads
- Low Noise Constant Frequency (1.2MHz) Operation
- Automatic Soft-Start Reduces Inrush Current
- Shutdown Current $<1\mu$ A
- Short-Circuit Protection
- No Inductors
- Available in Low Profile 6-Lead SOT23 Package

Application

- 2 AA Cell to 3.3V
- USB On-The-Go Devices
- White LED Drivers
- Handheld Devices

Description

The HX4002B is a low noise, constant frequency (1.2MHz) switched capacitor voltage doubler. It produce a regulated output voltage from a 1.8V to 5V input with up to 150mA of output current. Low external parts count (one flying capacitor and two small bypass capacitors at VIN and VOUT) make the HX4002B ideally suited for small, battery-powered applications.

A new charge-pump architecture maintains constant switching frequency to zero load and reduces both output and input ripple. The HX4002B have thermal shutdown capability and can survive a continuous short circuit from VOUT to GND. Built-in soft-start circuitry prevents excessive inrush current during start-up.

High switching frequency enables the use of small ceramic capacitors. A low current shutdown feature disconnects the load from VIN and reduces quiescent current to $<1\mu$ A.

The HX4002B is available in the 6-pin SOT23-6.



Typical Applications

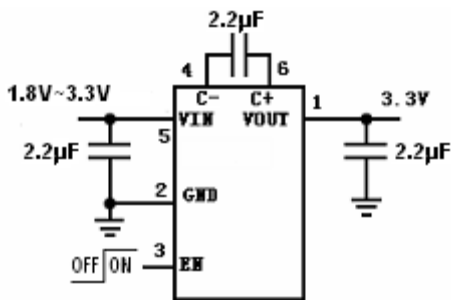

Figure 1: Regulated 3.3V Output

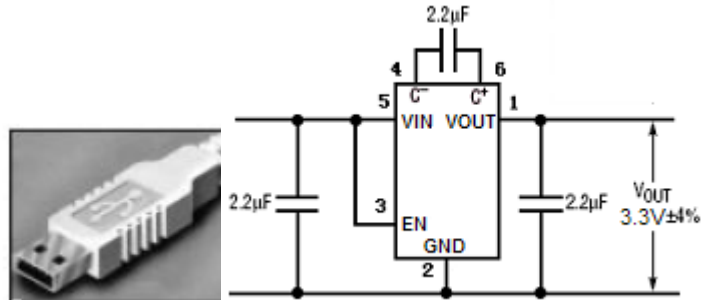

Figure 2: USB Port to Regulated 3.3V Power Supply

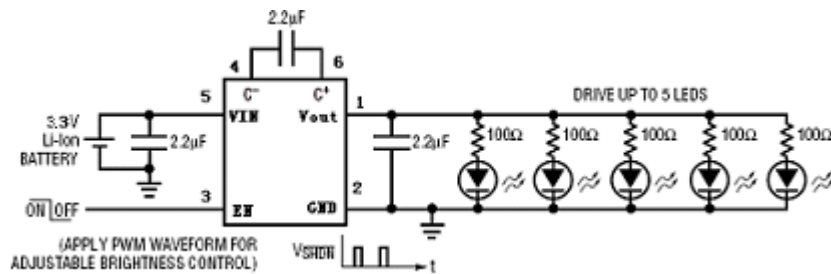
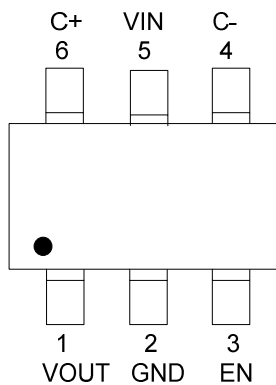

Figure 3: Lithium-Ion Battery to 5V White or Blue LED Drivers

Pin Description



PIN NUMBER SOT-23-6	PIN NAME
1	VOUT
2	GND
3	EN
4	C-
5	VIN
6	C+



Absolute Maximum Ratings (Note 1)

- V_{IN} - 0.3V to 6V
- V_{OUT} - 0.3V to 3.5V
- V_{OUT} Short-circuit Duration.....indefinite
- V_{EN} - 0.3V to 6V
- I_{OUT} (Note 2) 150mA
- Operating Temperature Range (Note 3).....- 30°C to 85°C
- Lead Temperature (Soldering 10 sec.)300°C
- Storage Temperature Range- 65°C to 125°C

Note 1: Absolute Maximum Ratings are those values beyond which the life of a device may be impaired.

Note 2: Based on long term current density limitations.

Note 3: The HX4002B are guaranteed to meet performance specifications from 0°C to 70°C. Specifications over the -40°C to 85°C operating temperature range are assured by design, characterization and correlation with statistical process controls.

Electrical Characteristics

The specifications are at $T_A = 25^\circ\text{C}$. $V_{IN} = 3.6\text{V}$, $EN = V_{IN}$, $C_{IN} = C_{OUT} = 2.2\mu\text{F}$ or $1\mu\text{F}$ unless otherwise noted.

PARAMETER	CONDITIONS	MIN	TYP	MAX	UNITS
Input Voltage Range (V_{IN})		1.8		5.5	V
Output Voltage Range (V_{OUT})	$2.7\text{V} < V_{IN} < 5.5\text{V}$, $I_{OUT} < 65\text{mA}$		3.3		V
I_{SHDN} Shutdown Current	$EN = 0\text{V}$, $V_{OUT} = 0\text{V}$	0.3	0.5	0.9	μA
No load input current	$I_{OUT} = 0\text{mA}$, $V_{IN} = 2.7\text{V}$		1.77		mA
Output current limit			150		mA
Output Ripple (VR)	$I_{OUT} = 100\text{mA}$		20		mVP-P
Switching Frequency (f_{osc})			1.2		MHz



Typical Performance Characteristics

No Load Supply Current vs. Supply Voltage

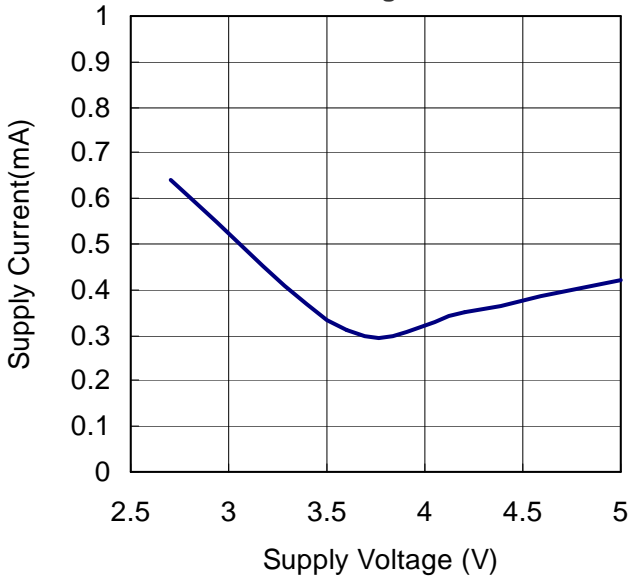

Output Voltage vs. Supply Voltage (IOUT=0A)

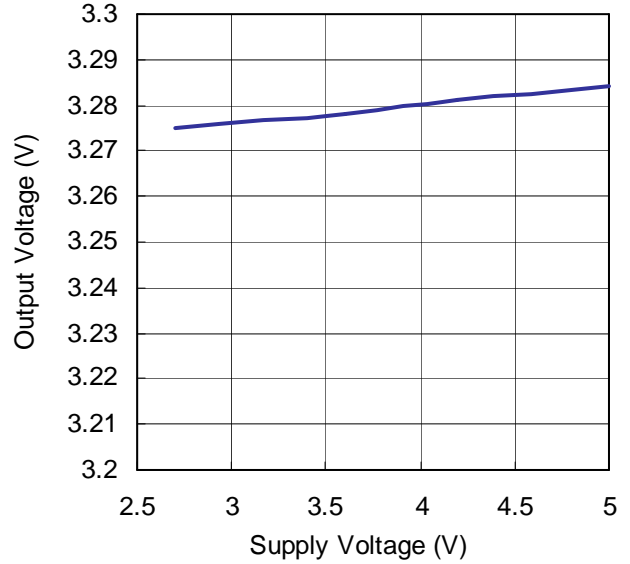

Oscillator Frequency vs. Supply Voltage (IOUT=0A)

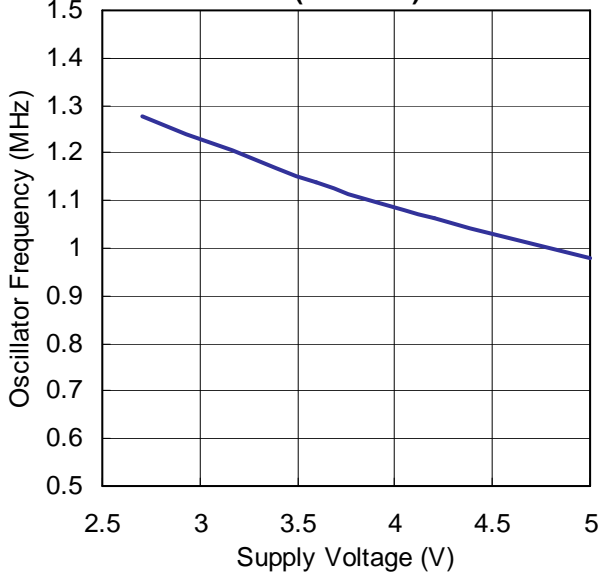

Short Circuit Current vs. Supply Voltage

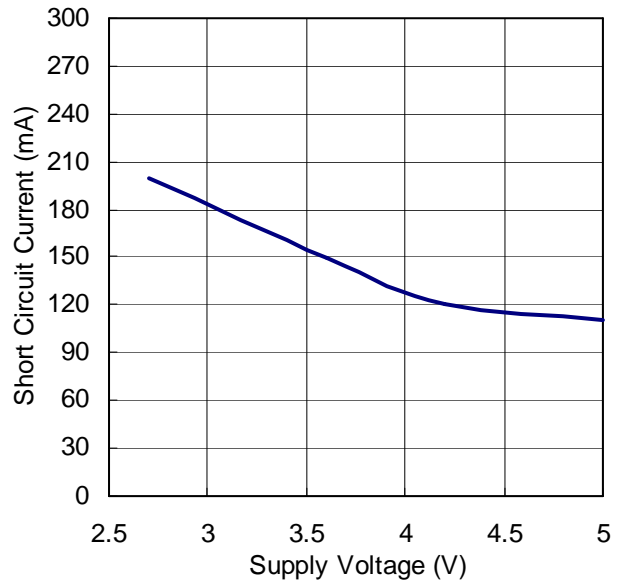



VIN=2.7V ILOAD=0A

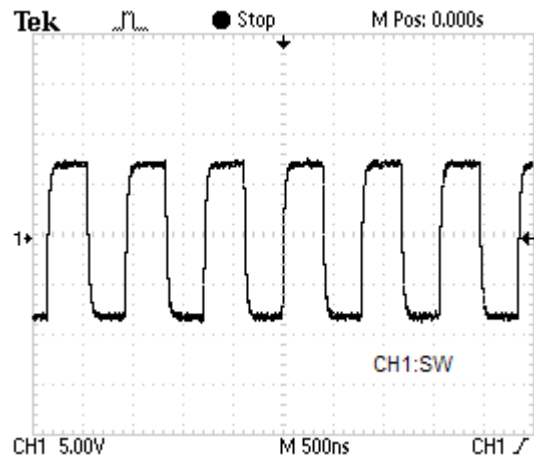
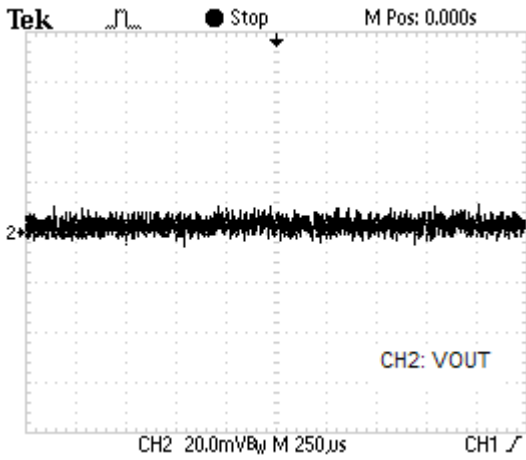

VIN=2.7V ILOAD=220mA

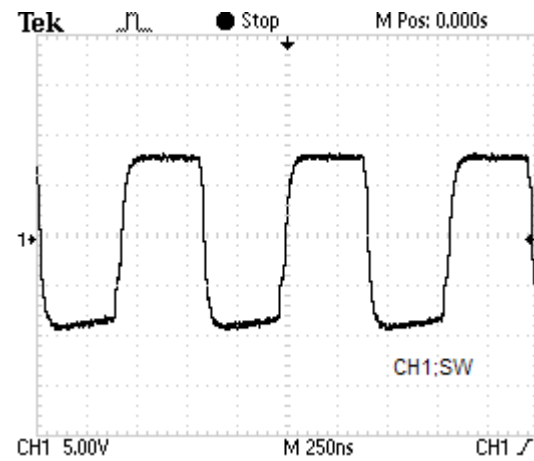
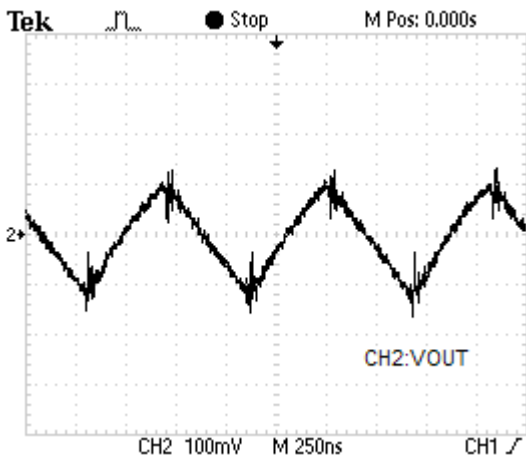

VIN=3.6V ILOAD=0A

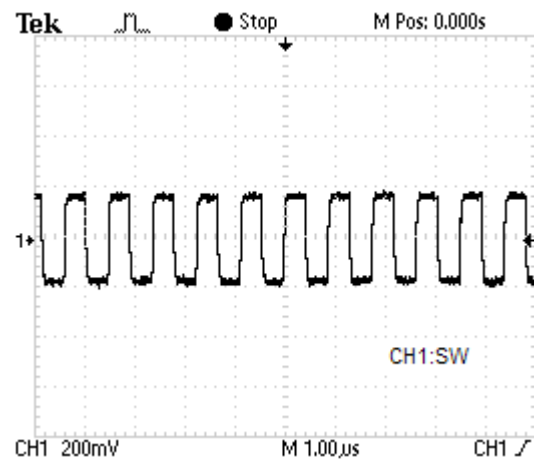
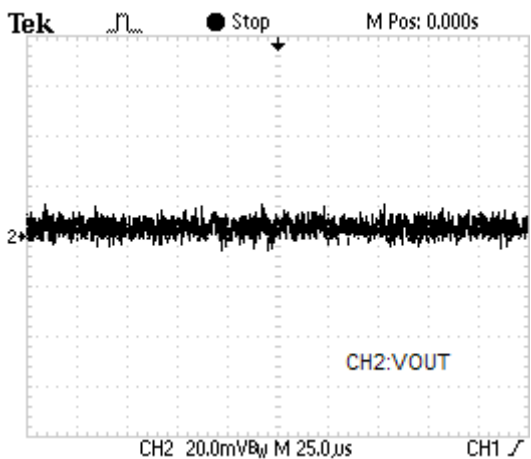



VIN=3.6V ILOAD=180mA

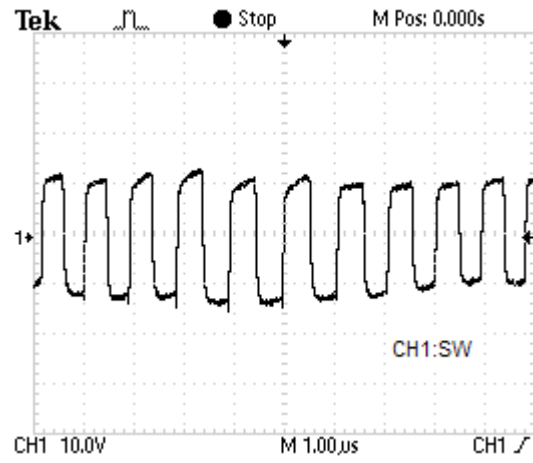
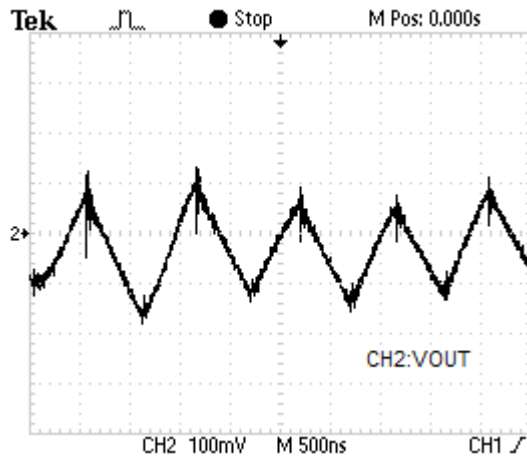

VIN=4.2V ILOAD=0mA

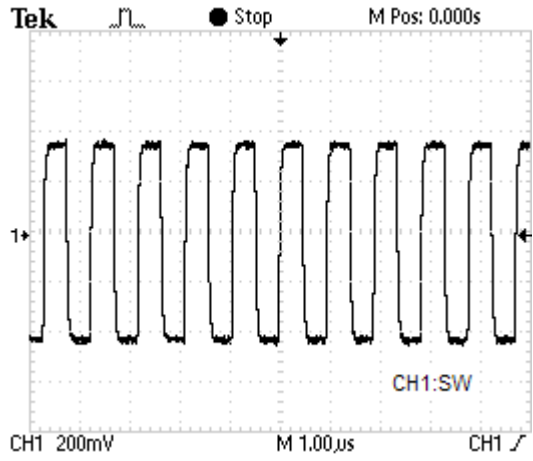
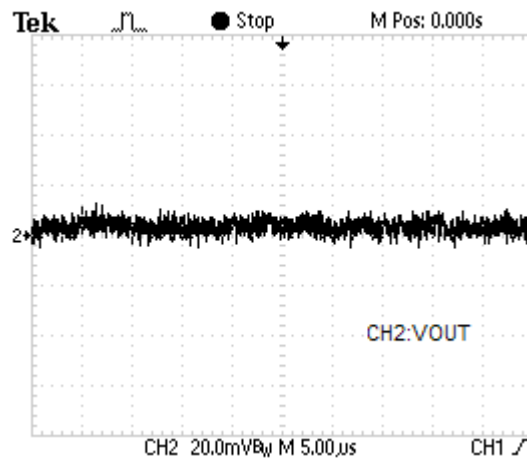

VIN=4.2V ILOAD=140mA

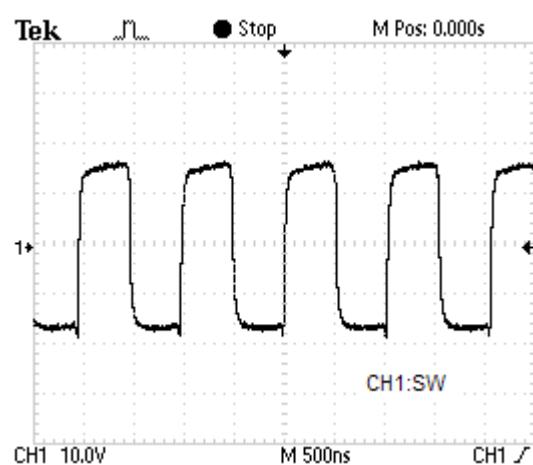
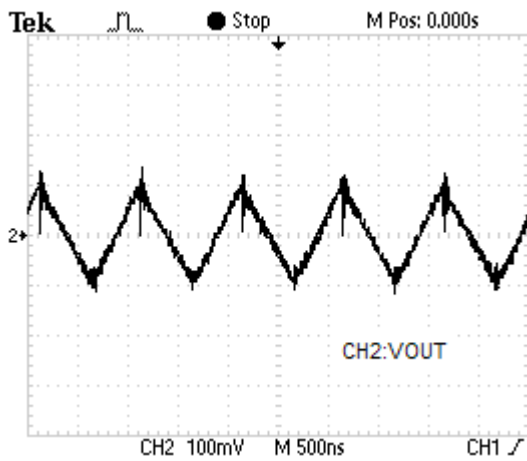



VIN=5V ILOAD=0mA

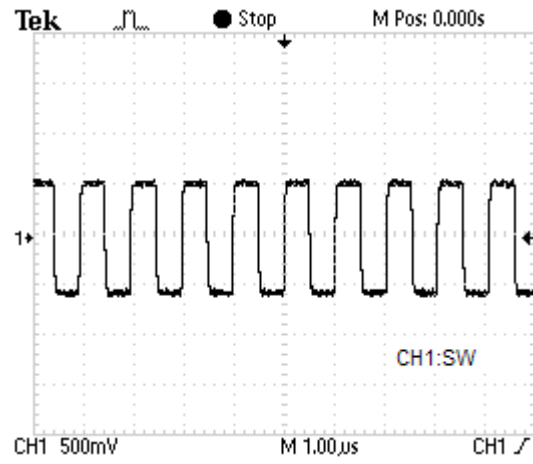
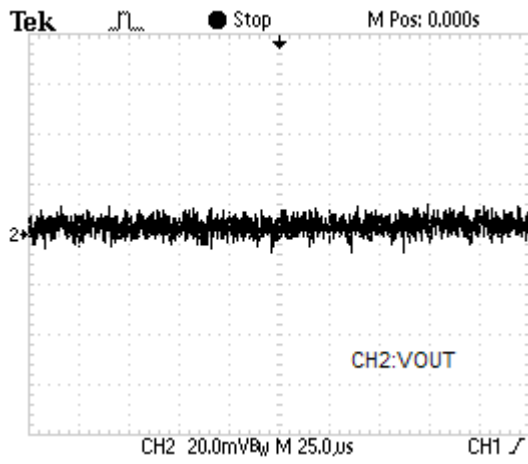

VIN=5V ILOAD=120mA

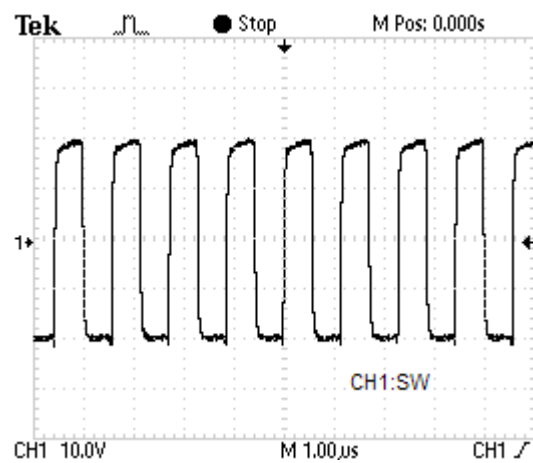
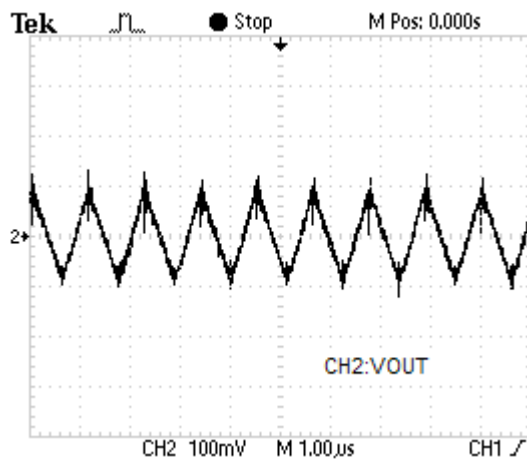



Pin Functions

VOUT (Pin 1): Regulated Output Voltage. VOUT should be bypassed with a low ESR ceramic capacitor providing at least 2 μ F of capacitance as close to the pin as possible for best performance.

GND (Pin 2): Ground. These pins should be tied to a ground plane for best performance. The exposed pad must be soldered to PCB ground to provide electrical contact and optimum thermal performance.

EN (Pin 3): Active Low Shutdown Input. This pin must not be allowed to float.

C- (Pin 4): Flying Capacitor Negative Terminal.

VIN (Pin 5): Input Supply Voltage. VIN should be bypassed with a 1 μ F to 4.7 μ F low impedance ceramic capacitor.

C+ (Pin 6): Flying Capacitor Positive Terminal.

Application Information

Operation

The HX4002B use a switched capacitor charge pump to boost VIN to a regulated output voltage. Regulation is achieved by sensing the output voltage through an internal resistor divider and modulating the charge pump output current based on the error signal. A 2-phase nonoverlapping clock activates the charge pump switches. The flying capacitor is charged from VIN on the first phase of the clock. On the second phase of the clock it is stacked in series with VIN and connected to VOUT. This sequence of charging and discharging the flying capacitor continues at a free running frequency of 1.2MHz (typ).

In shutdown mode all circuitry is turned off and the HX4002B draw only leakage current from the VIN supply. Furthermore, VOUT is disconnected from VIN. The EN pin is a CMOS input with a threshold voltage of approximately 0.8V. The HX4002B is in shutdown when a logic low is applied to the EN pin. Since the EN pin is a high impedance CMOS input it should never be allowed to float. To ensure that its state is defined it must always be driven with a valid logic level.

Short-Circuit Protection

The HX4002B have built-in short-circuit current limiting. During short-circuit conditions, they will automatically limit their output current to approximately 200mA.

Soft-Start

The HX4002B have built-in soft-start circuitry to prevent excessive current flow at VIN during start-up. The soft-start time is preprogrammed to approximately 1ms, so the start-up current will be primarily dependent upon the output capacitor.



VIN, VOUT Capacitor Selection

The style and value of capacitors used with the HX4002B determine several important parameters such as regulator control loop stability, output ripple, charge pump strength and minimum start-up time.

To reduce noise and ripple, it is recommended that low ESR (< 0.1Ω) ceramic capacitors be used for both CIN and COUT. These capacitors should be 0.47uF or greater. Tantalum and aluminum capacitors are not recommended because of their high ESR.

The value of COUT directly controls the amount of output ripple for a given load current. Increasing the size of COUT will reduce the output ripple at the expense of higher minimum turn on time and higher start-up current. The peak-to-peak output ripple is approximately given by the expression:

$$V_{\text{RIPPLE-P}} \cong \frac{I_{\text{OUT}}}{2f_{\text{OSC}} \cdot C_{\text{OUT}}}$$

Where f_{osc} is the HX4002B oscillator frequency (typically 1.2MHz) and COUT is the output charge storage capacitor.

Both the style and value of the output capacitor can significantly affect the stability of the HX4002B. The HX4002B use a linear control loop to adjust the strength of the charge pump to match the current required at the output. The error signal of this loop is stored directly on the output charge storage capacitor. The charge storage capacitor also serves to form the dominant pole for the control loop. To prevent ringing or instability on the HX4002B it is important for the output capacitor to maintain at least 0.47uF of capacitance over all conditions.

Likewise excessive ESR on the output capacitor will tend to degrade the loop stability of the HX4002B. Ceramic capacitors typically have exceptional ESR performance and combined with a tight board layout should yield very good stability and load transient performance.

As the value of COUT controls the amount of output ripple, the value of CIN controls the amount of ripple present at the input pin (VIN). The input current to the HX4002B will be relatively constant while the charge pump is on either the input charging phase or the output charging phase but will drop to zero during the clock nonoverlap times. Since the nonoverlap time is small (25ns), these missing “notches” will result in only a small perturbation on the input power supply line. Note that a higher ESR capacitor such as tantalum will have higher input noise due to the input current change times the ESR. Therefore ceramic capacitors are again recommended for their exceptional ESR performance.

Flying Capacitor Selection

Warning: A polarized capacitor such as tantalum or aluminum should never be used for the flying capacitor since its voltage can reverse upon start-up of the HX4002B. Low ESR ceramic capacitors should always be used for the flying capacitor.

The flying capacitor controls the strength of the charge pump. In order to achieve the rated output current it is necessary to have at least 0.68uF of capacitance for the flying capacitor.



For very light load applications the flying capacitor may be reduced to save space or cost. The theoretical minimum output resistance of a voltage doubling charge pump is given by:

$$R_{OL(MIN)} \equiv \frac{2V_{IN} - V_{OUT}}{I_{OUT}} \equiv \frac{1}{f_{OSC}C_{FLY}}$$

Where fosc is the switching frequency (1.2MHz typ) and CFLY is the value of the flying capacitor. The charge pump will typically be weaker than the theoretical limit due to additional switch resistance, however for very light load applications the above expression can be used as a guideline in determining a starting capacitor value.

Power Efficiency

The power efficiency of the HX4002B is similar to that of a linear regulator with an effective input voltage of twice the actual input voltage. This occurs because the input current for a voltage doubling charge pump is approximately twice the output current. In an ideal regulating voltage doubler the power efficiency would be given by:

$$\eta \equiv \frac{P_{OUT}}{P_{IN}} = \frac{V_{OUT} \cdot I_{OUT}}{V_{IN} \cdot 2I_{OUT}} = \frac{V_{OUT}}{2V_{IN}}$$

At moderate to high output power the switching losses and quiescent current of the HX4002B are negligible and the expression above is valid.

Layout Considerations

Due to its high switching frequency and the high transient currents produced by the HX4002B, careful board layout is necessary. A true ground plane and short connections to all capacitors will improve performance and ensure proper regulation under all conditions. Figure 4 shows an example layout for the HX4002B.

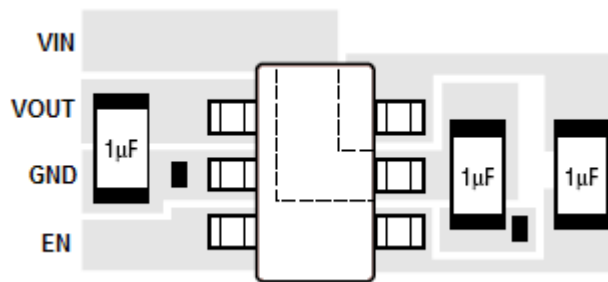
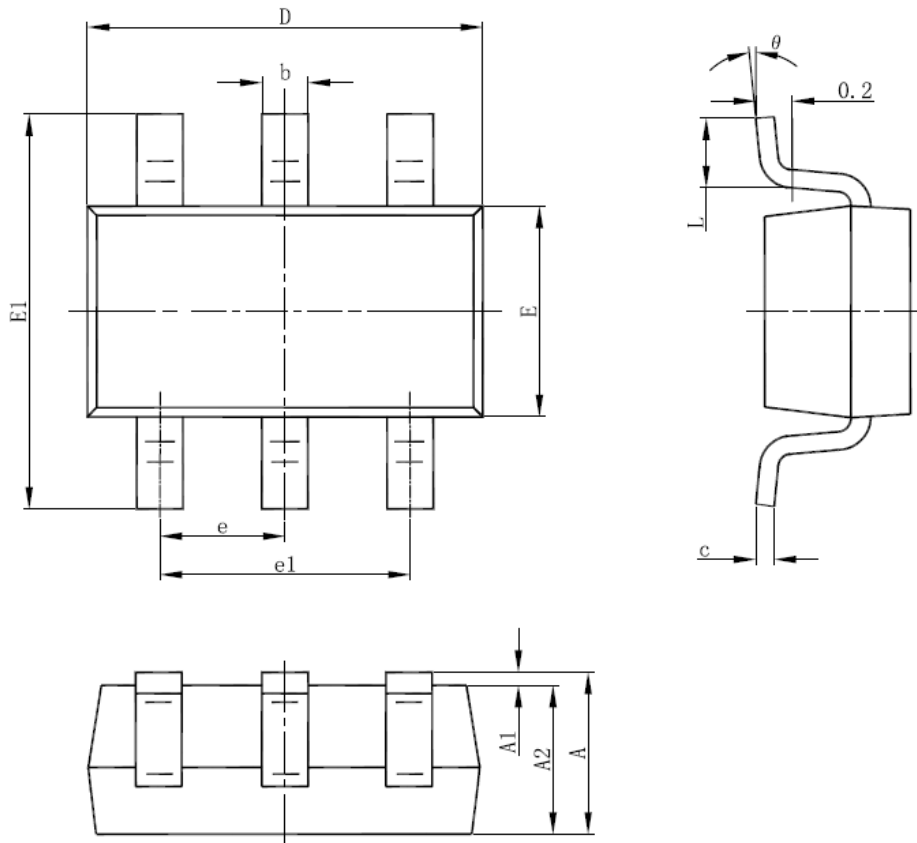

Figure 4: Recommended Layout

Packaging Information

SOT-23-6 Package Outline Dimension



Symbol	Dimensions In Millimeters		Dimensions In Inches	
	Min	Max	Min	Max
A	1.050	1.250	0.041	0.049
A1	0.000	0.100	0.000	0.004
A2	1.050	1.150	0.041	0.045
b	0.300	0.500	0.012	0.020
c	0.100	0.200	0.004	0.008
D	2.820	3.020	0.111	0.119
E	1.500	1.700	0.059	0.067
E1	2.650	2.950	0.104	0.116
e	0.950(BSC)		0.037(BSC)	
e1	1.800	2.000	0.071	0.079
L	0.300	0.600	0.012	0.024
θ	0°	8°	0°	8°

Subject changes without notice