

PZEM-022 100A AC Digital Power Monitor Voltmeter Ammeter Frequency Factor Meter

Product Description

Features:

1. Electrical parameter measurement function (voltage, current, active power, energy, frequency, power factor)
2. Overload alarm function (over power alarm threshold, backlight and power flashing to alarm)
3. Power alarm threshold preset function (can set power alarm threshold)
4. The energy can be reset use the key
5. Store data when power off
6. Large-screen LCD
7. Backlight function
8. Key Function

◆Backlight control

Short press the key to turn on or off the backlight, the backlight has memory function, it can store the on or off state when power off.

◆Reset energy

Step1: Long press the key for 5 seconds until the energy value flash, then release the key.

Step2: Short press the key again, then the energy value is cleared and exit the reset flashing state.

Step3: If there is no operation on the key within 5 seconds, it means the energy value is not cleared and will exit the reset state.

◆Set power alarm threshold

Step1: Long press the key until the LCD screen display "SET CLr", then release the key to enter the setting state

Step2: Power window display the current power alarm value and the last digit begin to flash, then you can short press to plus 1, when there is no operating over 3 seconds, it will switch the digit position automatically, the setting method is as same as the above.

Step3: After finish the setting, long press the key over 5 seconds will store automatically and exit, the range of active power threshold is 0.0~2.5kW. it can display six parameters at the same time.

Specifications:

1. Working voltage: 80 ~ 260VAC
2. Test voltage: 80 ~ 260VAC
3. Rated power: 100A/22000W
4. Operating frequency: 45-65Hz
5. Measurement accuracy: 1.0 grade

Display format:

1.Power

Test range: 0~22000W

Starting measure power: 0.2W

<10W display format: 1.00~9.99W

<100W display format: 10.0~99.9W

<1000W display format: 100~999W

<10000W display format: 1.00~9.90kW

≥10000W display format: 10.0~22.0kW

2.Energy

Test range: 0~999kWh

<1kWh display format: 0~999Wh

<10kWh display format: 1.00~9.99kWh

≥10kWh display format: 10~999kWh

3.Voltage

Test range: 80~260V

Display format: 80~260V

4.Current

Test range: 0~100A

Starting measure current: 0.001A

<10A display format:0.000~9.000A

≥10A display format:10.00~99.99A

5.Frequency

Test range: 45~65Hz

Display format: 45~65Hz

6.Power factor

Test range: 0~1PF

Display format: 0.00~1.00PF

Precautions:

1. This module is suitable for indoor, please do not use outdoor.
2. Applied load should not exceed the rated power.
3. Wiring order can't be wrong.

Package Included:

1 x Open and Close CT Power Monitor

Detail Pictures:





PZEM-022

Open and Close CT 100A

Large-screen LCD

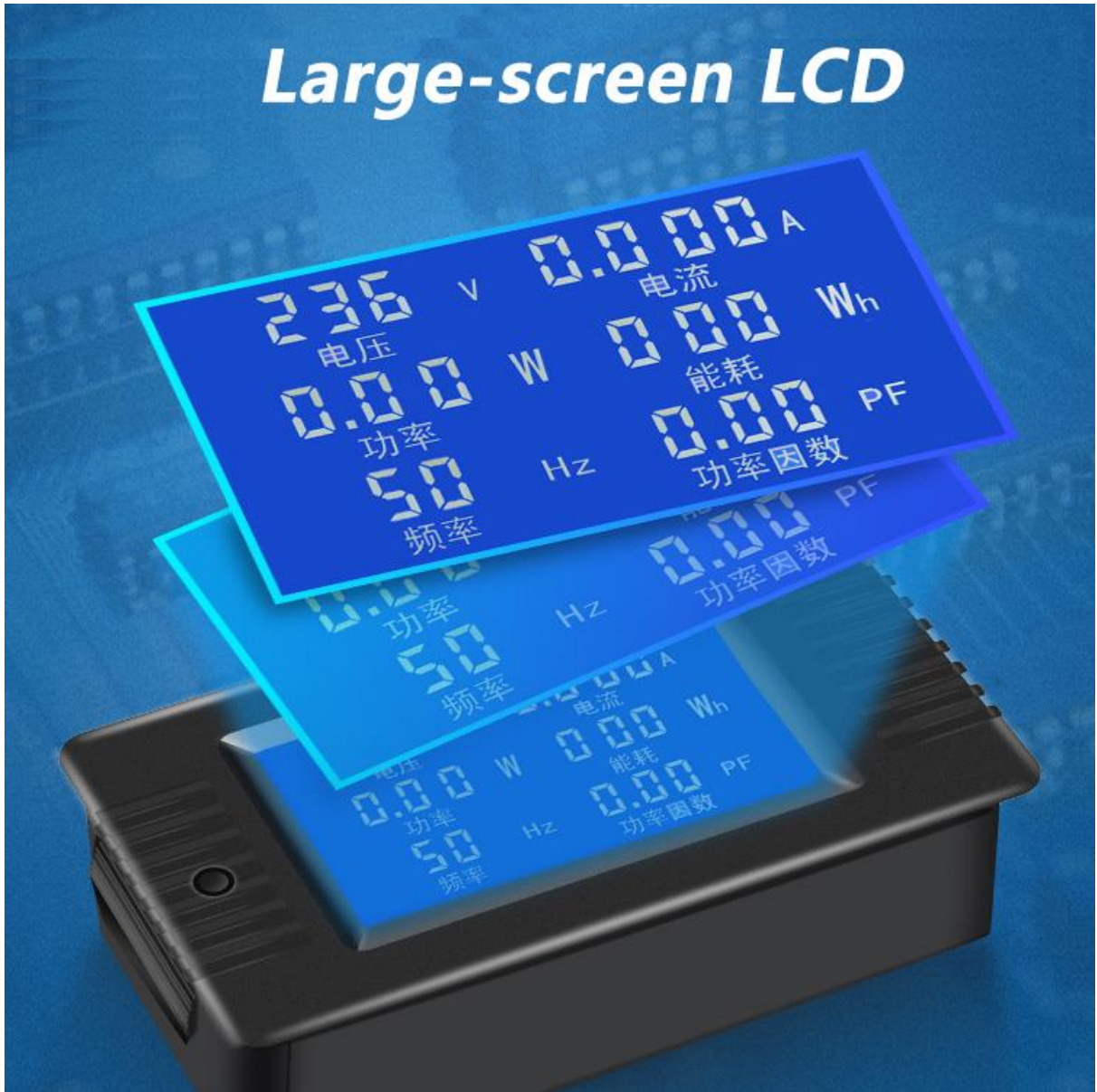

Backlight control



Exploded Pictures

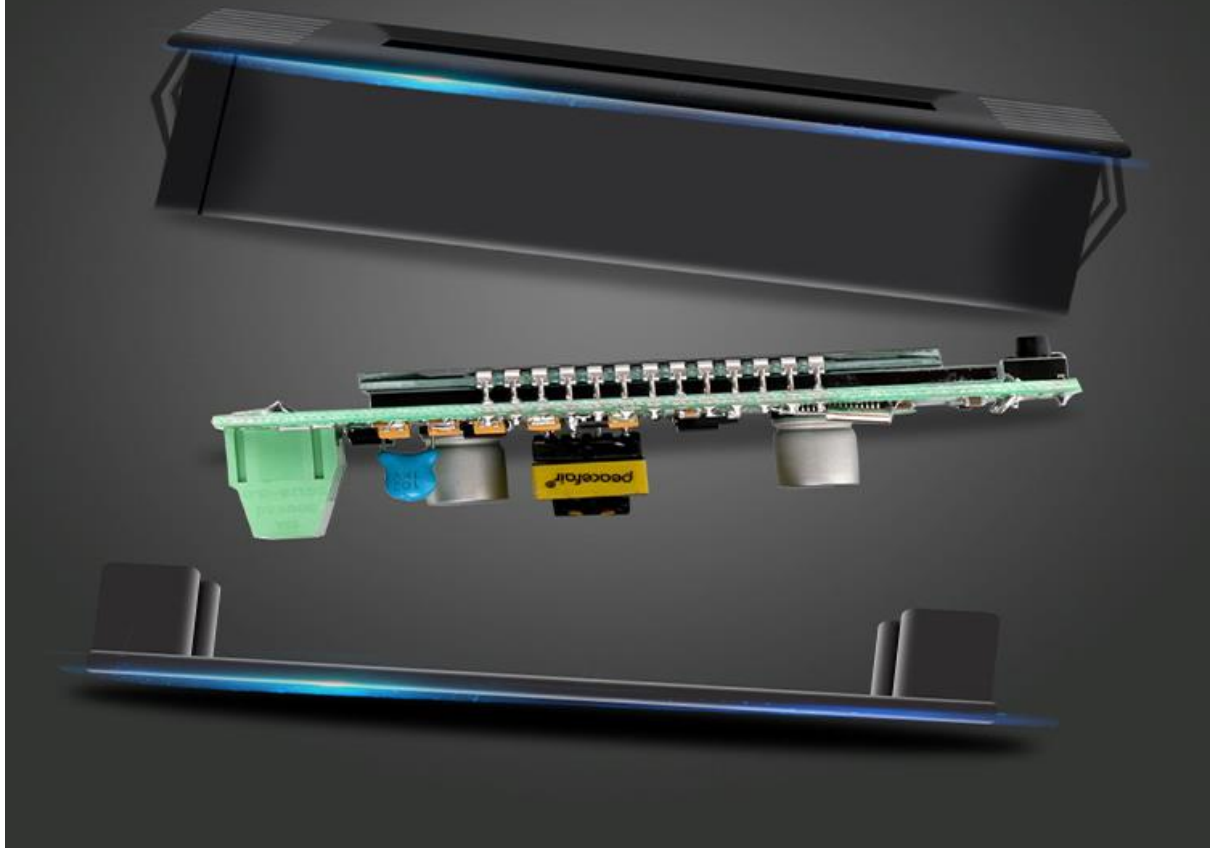

Comfortable Hand Feeling





PZEM-022

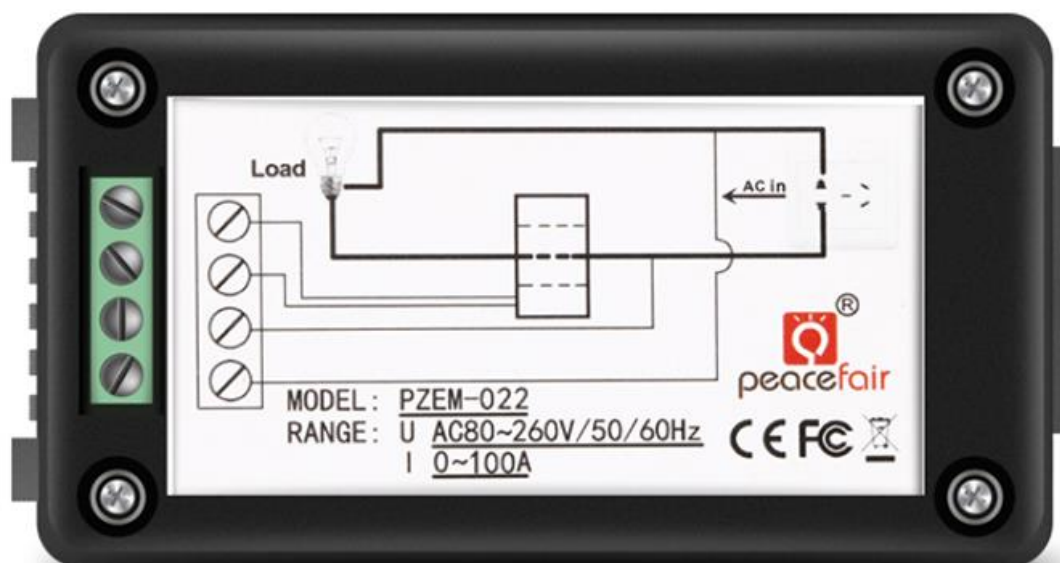

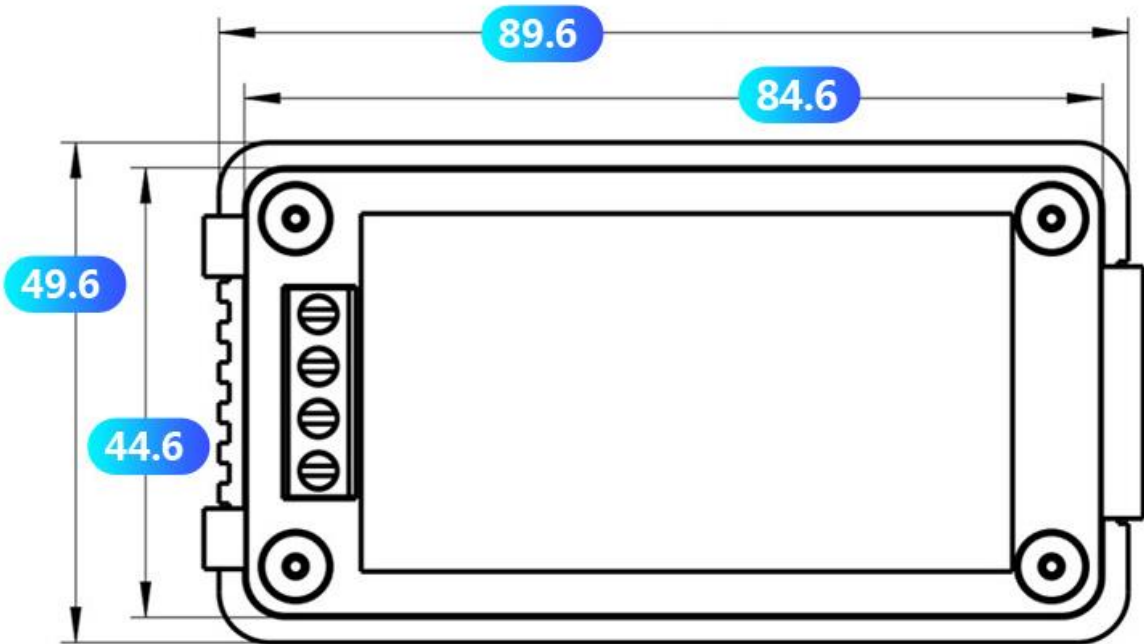
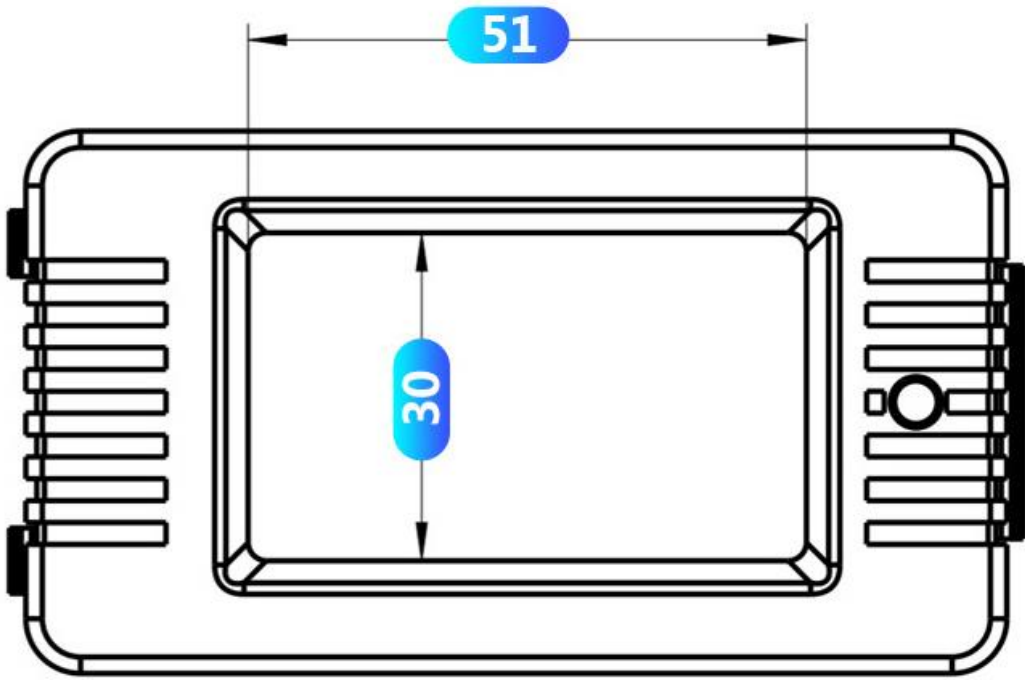

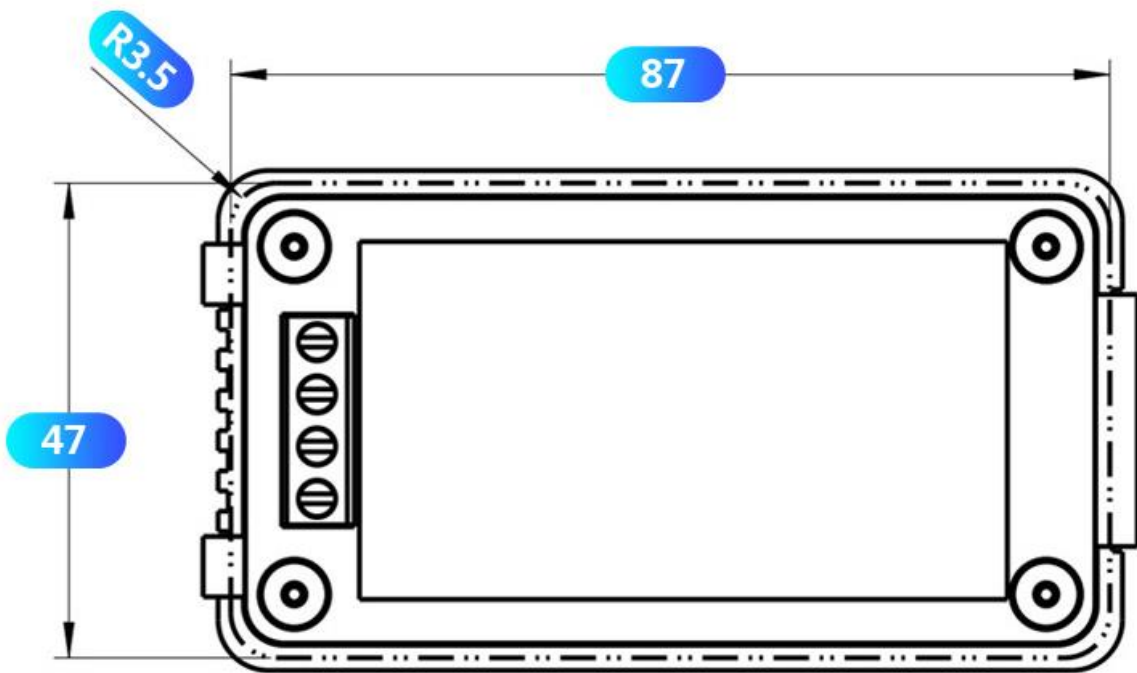
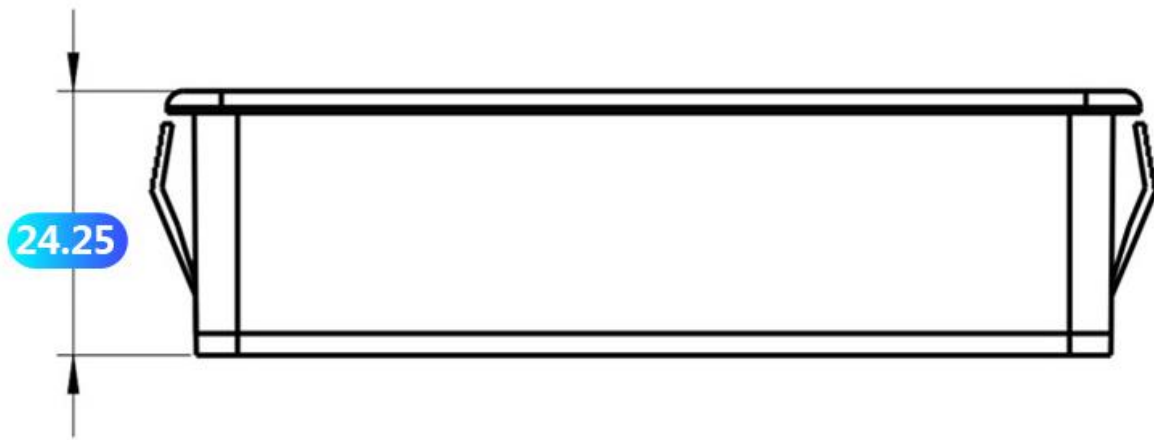

More Detailed Photos:











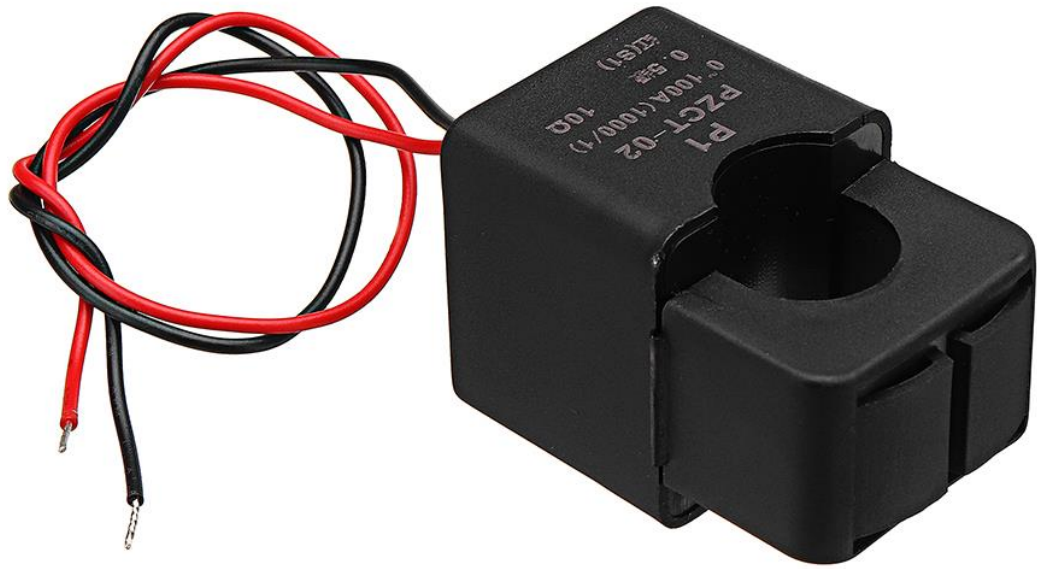

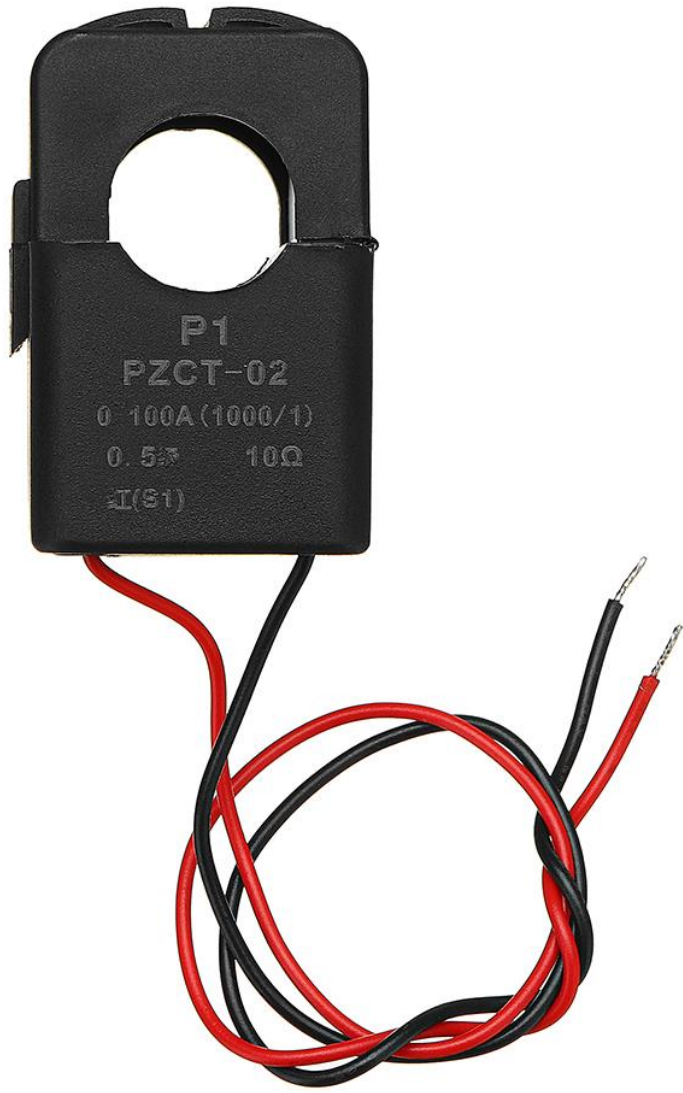

P1

PZCT-02

0 100A (1000/1)

0.5% 10Ω

I(S1)



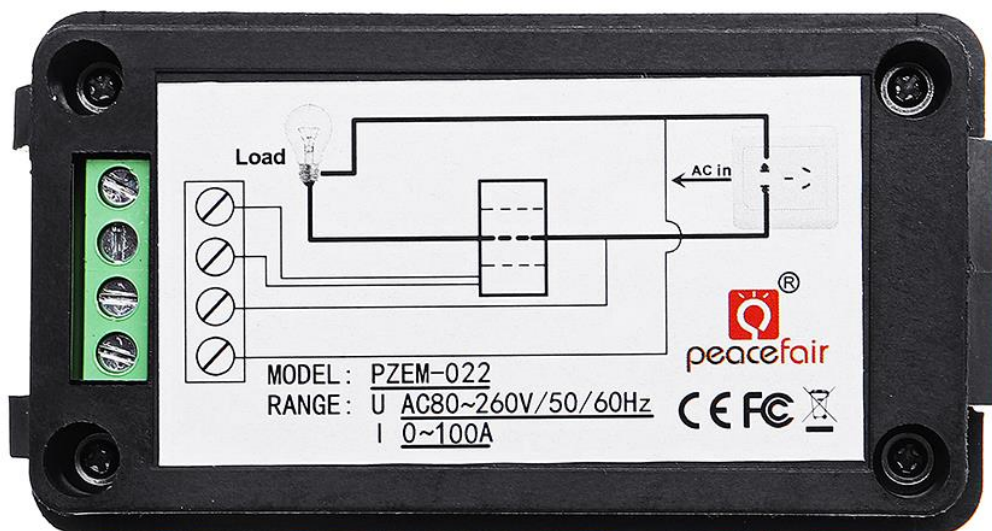

[BUY NOW](#)