

# AUDIO SIGNAL GENERATOR

GAG-809/810

---

## USER MANUAL

GW INSTEK PART NO. 82AG-81000M11



ISO-9001 CERTIFIED MANUFACTURER

**GW INSTEK**

## CONTENTS

<b>Features.....</b>	<b>1</b>
<b>Specifications.....</b>	<b>2</b>
<b>Circuit Description.....</b>	<b>5</b>
<b>Panel Controls and Their Functions.....</b>	<b>8</b>
<b>Operating Instructions.....</b>	<b>11</b>
<b>Applications.....</b>	<b>14</b>
<b>Adjustment and Calibration.....</b>	<b>19</b>
<b>Caution.....</b>	<b>21</b>

## A. SAFETY TERMS AND SYMBOLS

These terms may appear in this manual or on the product:

 **WARNING.** Warning statements identify condition or practices that could result in injury or loss of life.

 **CAUTION.** Caution statements identify conditions or practices that could result in damage to this product or other property.

The following symbols may appear in this manual or on the product:



**ATTENTION**  
refer to Manual



**Protective  
Conductor  
Terminal**



**Earth  
(Ground)  
Terminal**

## B. FUSE REPLACEMENT

The main AC line fuse is located on the rear panel next to the line power receptacle. Remove the line power cord and test lead before attempting to remove the fuse. For continued fire protection. Replace fuse only with the specified type and rating.

## C. CLEANING

Remove the AC input power (disconnect and remove the power cord) and test lead from the instrument before attempting to clean the instrument.

To keep the instrument clean, wipe the case with a damp cloth and detergent. Do not use chemicals containing benzene, benzene, toluene, xylene, acetone, abrasives or similar solvents.

## D. FOR UNITED KINGDOM ONLY

### NOTE

**This lead/appliance must only  
be wired by competent persons**

### WARNING

**THIS APPLIANCE MUST BE  
EARTHED  
IMPORTANT**

**The wires in this lead are  
coloured in accordance with  
the following code:**

**Green/**

**Yellow: Earth**

**Blue: Neutral**

**Brown: Live(Phase)**



As the colours of the wires in main leads may not correspond with the colours marking identified in your plug/appliance, proceed as follows:

The wire which is coloured Green & Yellow must be connected to the Earth terminal marked with the letter E or by the earth symbol  $\oplus$  or coloured Green or Green & Yellow

The wire which is coloured Blue must be connected to the terminal which is marked with the letter N or coloured Blue or Black.

The wire which is coloured Brown must be connected to the terminal marked with the letter L or P or coloured Brown or Red.

If in doubt, consult the instructions provided with the equipment or contact the supplier.

This cable/appliance should be protected by a suitably rated and approved HBC mains fuse : refer to the rating information on the equipment and/or user instructions for details. As a guide, cable of 0.75mm<sup>2</sup> should be protected by a 3A or 5A fuse. Larger conductors would normally require 13A types, depending on the connection method used.

Any moulded mains connector that requires removal/replacement must be destroyed by removal of any fuse & fuse carrier and disposed of immediately, as a plug with bared wires is hazardous if engaged in a live socket! Any re-wiring must be carried out in accordance with the information detailed on this label.

## 1. FEATURES

- **Low sine wave distortion, high stability, shorter warm-up time and less power consumption.**
- **High reliability with adoption of direct coupled circuits throughout the entire stage.**
- **Compact styling with vertical type panel for easy operation.**
- **Frequency dial scale calibrated with single-scale graduations for frequency range from 10Hz to 1MHz selectable in 5 ranges.**
- **High output design; more than 5V rms at 600  $\Omega$  (Sine Wave). Output level is fully adjustable with a 10dB-step, 6 range attenuator and a level adjuster.**
- **Low output impedance of 600  $\Omega$ . The attenuator provides accuracy of  $\pm 1.0$ dB at 600  $\Omega$  load.**
- **Sine and square waves easily available.**
- **External Synchronizing input terminal.**

## 2.SPECIFICATIONS

### 2.1 Frequency range:

- × 1 range: 10Hz-100Hz
- × 10 range: 100Hz-1kHz
- × 100 range: 1kHz-10kHz
- × 1K range: 10kHz-100kHz
- × 10K range: 100kHz-1MHz

### 2.2 Frequency accuracy:

±(5%+1Hz) (at 10,100 position, Except × 1 Range)

### 2.3 [Sine Wave Characteristics]:

- Output voltages: 5V rms or more(600 Ω load).
- Frequency characteristics: 10Hz - 1MHz, ± 0.5dB (reference freq: 1kHz, 600 Ω load).
- Distortion factor:

GAG-809:

500Hz-20kHz: 0.1 % or less

100Hz-100kHz: 0.3 % or less (× 10 range for 100Hz, × 1K range for 100kHz)

50Hz-200kHz: 0.3 % or less

20Hz-500kHz: 0.5 % or less

10Hz-1MHz: 1.5 % or less

### GAG-810:

500Hz-20kHz: 0.02 % or less

100Hz-100kHz: 0.05 % or less ( $\times 10$  range for 100Hz,  $\times 1K$  range for 100kHz)

50Hz-200kHz: 0.3 % or less

20Hz-500kHz: 0.5 % or less

10Hz-1MHz: 1.5 % or less

### 2.4 [Square Wave Characteristics]:

- Output voltage: 10V p-p or more (no load).
- Rise and fall times: 200ns or less
- Overshoot: 2 % or less (at 1kHz, max.output)
- Duty ratio: 50 %  $\pm$  5 % (at 1kHz, max.output)

### 2.5 [External Synchronization Characteristics]:

- Synchronizing range:  $\pm 1$  %/V
- Max.allowable input: 15V (DC+ACpeak)
- Input impedance: Approx.150k  $\Omega$

### 2.6 Output impedance: Approx.600 $\Omega$

### 2.7 Output attenuator: 0dB, -10dB, -20dB, -30dB, -40dB and -50dB in 6 steps (accuracy: $\pm 1$ dB at 600 $\Omega$ load)

## 2.8 Enviromental:

- Indoor use : Altitude up to 2000m
- Installation category II : Pollution degree 2
- Within specification temperature/humidity range:  $23^{\circ}\text{C} \pm 5^{\circ}\text{C}$  (RH $\leq$ 85%)
- Operation temperature/humidity range: 0 ~ 40  $^{\circ}\text{C}$ , 85% RH

2.9 Power requirement: 100/120/220/230VAC  $\pm$  10%(Max.250VAC), 50-60Hz

2.10 Power consumption: 8watts/10VA

## 2.11 Dimensions:

- Casing: 200(W)  $\times$  340(D)  $\times$  270(H) mm
- Overall(include knobs): 130(W)  $\times$  295(D)  $\times$  210(H) mm
- External view: See Fig.2

2.12 Weight: 3kg

## 2.13 Accessories:

- Power cord ..... 1
- Test Lead : GTL-103 ..... 1
- Instruction manual ..... 1



### 3. CIRCUIT DESCRIPTION

#### 3.1 Summary

When reading the following descriptions, refer to the block diagram (Fig. 1).

The sine-wave signal generated by the Wien bridge oscillator circuit is fed through the WAVE FORM selector switch set at the "~" position to the AMPLITUDE control, by means of which it is adjusted to any desired voltage.

If the WAVE FORM switch is in the "⌋⌋" position, the sine-wave signal is shaped into the square wave and the voltage is also adjusted by the AMPLITUDE control.

The signal voltage thus adjusted is applied to the output circuit, where its impedance is appropriately converted, and then delivered through an output attenuator to the output terminal. The attenuator provides selectable attenuations of 0dB through -50dB in 10dB steps at 600  $\Omega$  of output impedance.

#### 3.2 Wien Bridge Oscillator Circuit

The Wien bridge oscillator circuit is composed of the resistance elements, capacity elements and amplifier circuit. which may be switched over for 5 range by the FREQ. RANGE switch, and the variable capacitor controlled by the FREQUENCY dial.

These elements provide means to vary the oscillating frequency continuously over 10 times its frequency on one range, thus determining any desired frequency within the entire frequency range from 10Hz to 1MHz.

The amplifier circuit for the oscillator circuit is composed of a compound differential amplifier and an output stage. The input circuit is a high input impedance circuit with FET while the amplifier stage is a wide band, high amplification type circuit with PNP transistors featuring high cut-off frequency. The output stage is a SEPP circuit using complementary transistors.

The output voltage is fed back with positive polarity through the resistance and capacity elements to form an oscillating circuit, while it is also fed back with negative polarity through the rectifier and the filter circuit and the variable resistance with FET to stabilize the amplitude.

### 3.3 Square Wave Shaping Circuit

The square wave shaping circuit is a Schmit-trigger circuit in which the sine wave signal from the oscillator circuit is shaped into a square wave. It provides sufficient rising and falling characteristics.

### 3.4 Output Circuit

The output circuit is a feedback amplifier. It is composed of a differential amplifier, a driver circuit and a SEPP-OCL circuit employing complementary transistors. It converts the impedance of signal from the AMPLITUDE control and amplifies the signal and feeds it to the output attenuator at a low impedance over the range from DC to 1MHz

### 3.5 Output Attenuator

The 6-position output attenuator selects attenuations of 0dB to -50dB in 10dB steps. At the 0dB position with the AMPLITUDE control turned fully clockwise, the output voltage (sine wave at a 600 Ω load) is more than 5V rms.

The output impedance is rated for 600 Ω and the attenuation accuracy is as  $\pm 1.0\text{dB}$  at a 600 Ω load.

### 3.6 Power Supply

The power supply circuit is powered by AC 100/120/220/230V and delivers DC  $\pm 24\text{V}$  sufficiently stabilized by large capacity smoothing capacitors and two voltage stabilizers.

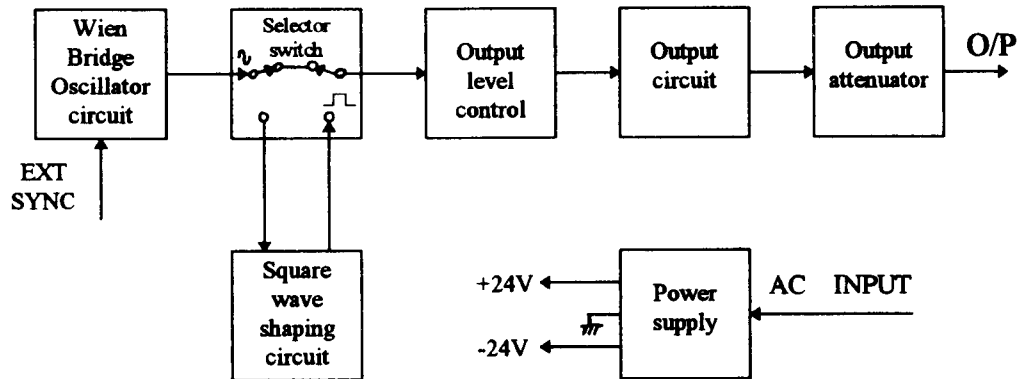

Fig.1 Block Diagram

## 4. PANEL CONTROLS AND THEIR FUNCTIONS

The table below describes the functions of panel controls. Refer to the panel diagram (Fig.2).

### ● FRONT PANEL

1. This lamp (light emitting diode) lights when POWER switch is ON.
2. POWER SWITCH: This switch applies or removes AC power.
3. ATTENUATOR: 6-position output attenuator selects attenuations of 0dB to -50dB in 10dB steps.
4. OUTPUT TERMINAL: Output terminal used for both sine wave and square wave. The Black terminal indicates GND (Case grounded)
5. WAVE FORM: Output waveform selector switch. When pressed to "~" output signal is sine wave. When pressed to "⎓" the signal is square wave.
6. FREQ. RANGE: Oscillating frequency range selector switch which selects the ranges in 5 steps as follows:

× 1	10Hz-100Hz
× 10	100Hz-1kHz
× 100	1kHz-10kHz
× 1K	10kHz-100kHz
× 10K	100kHz-1MHz

7. **AMPLITUDE:** Amplitude adjuster to continuously vary the amplitude of output voltage.
  8. **FREQUENCY DIAL:** This dial adjusts oscillating frequencies. Frequencies can be read by multiplying the reading on the dial scale by magnification of **FREQ. RANGE**.
  9. **DIAL SCALE:** This pointer indicates frequencies on the dial scale.
- **REAR PANEL**
10. **EXT SYNC:** External synchronizing signal input terminals for **GND** for connection of synchronizing signal to the instrument.
  11. **FUSE HOLDER:** Fuse for power supply.
  12. **AC CONNECTOR:** For connection of the supplied AC connector.

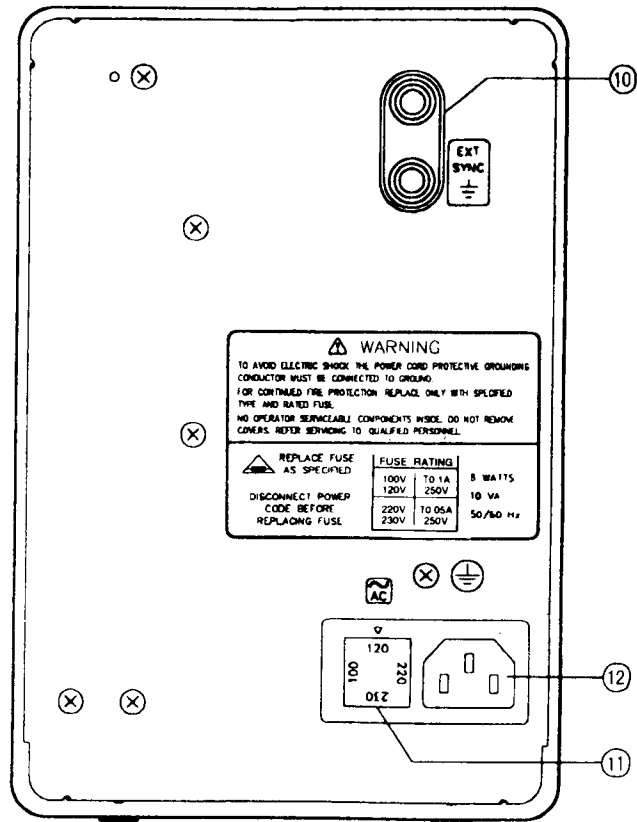
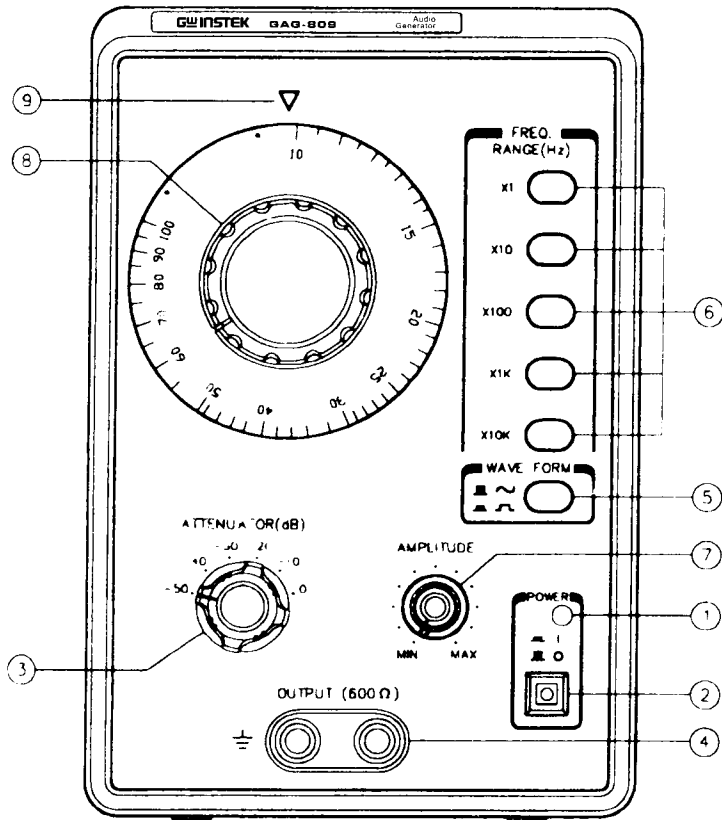

Fig.2

## 5. OPERATING INSTRUCTIONS

### 1. Start-up

First check that the fuse (11), then connect the supplied AC power cord to your AC outlet. Press the power switch (2) and the pilot lamp (1) will light indicating that the unit is ready for operation. Allow 2 or 3 minutes for the unit to warm up so that it is stabilized.

### 2. Waveform Selection

Press the WAVE FORM switch (5) to "~" position to obtain sine waves. Press the switch to the "□" position for square waves.

### 3. Frequency Selection

First set the FREQ. RANGE switch (6) to the desired range, then set the frequency dial (8) so that the dial pointer (9) indicates your frequency.

**Example:** Suppose you want to select a frequency of 1.5kHz, then proceed as follows:

1. Set FREQ. RANGE switch (6) to  $\times 100$  range.

2. By using the frequency dial, set the dial pointer (9) to "15" on the dial scale.

The frequency thus selected is:

$$15 \times 100 = 1500(\text{Hz}) = 1.5(\text{kHz})$$

#### 4. Adjustment of Output Voltage

The output voltage from OUTPUT terminal (4), sine wave or square wave, can be continuously varied by AMPLITUDE (7) and stepped down by ATTENUATOR (3).

Example: To adjust output voltage to 10mV rms, proceed as follows:

1. Connect a voltmeter capable of measuring AC 1V rms to OUTPUT terminal (4); Set ATTENUATOR (3) to 0dB and then adjust AMPLITUDE (7) until the voltmeter indicates 1V rms. A voltage of 1V rms will appear at OUTPUT terminal (4).
2. Set ATTENUATOR (3) to -40dB. The voltmeter indicates about 0V, while a voltage of 10mV rms appears at OUTPUT terminal (4).

5. Use of Synchronizing Input Terminal By applying an external sine wave signal to SYNC terminal (10), the oscillating frequency of instrument can be synchronized to the external signal. The synchronizing range is increased in proportion as the input voltage is increased as shown in Fig. 3, indicating that the synchronizing range is about  $\pm 1\%$  per input voltage of 1V.

Example:

If the signal of EXT SYNC terminal is 3Vrms/100KHz then the oscillating frequency of GENERATOR is between 97KHz and 103KHz.

If the signal of EXT SYNC terminal is 5Vrms/100KHz then the oscillating frequency of GENERATOR is between 95KHz and 105KHz.



Note: that too high a synchronizing signal voltage will affect the amplitude and distortion factor, and care must therefore be taken when the signal voltage is higher than 3V rms. Also, note that if the synchronizing signal is largely deviated from the frequency of instrument the synchronization is pulled out which affects the distortion factor. It is therefore advisable that the oscillating frequency be first synchronized with a low input signal voltage (less than 1V rms) and then the voltage be increased.

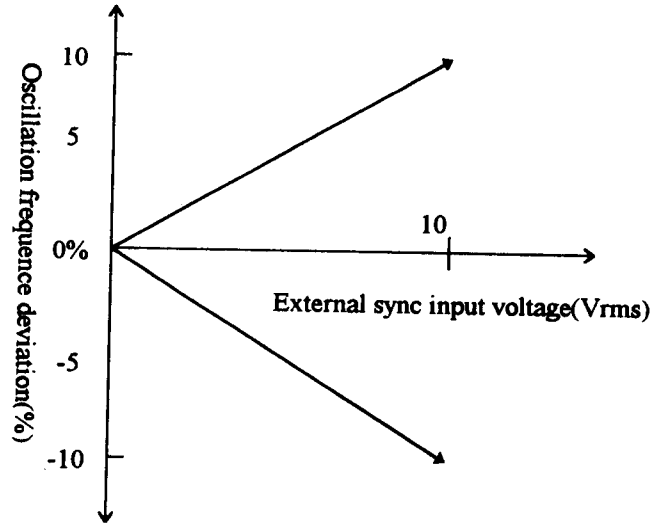

Fig.3

## 6.APPLICATIONS

### 1. Using as Sine Wave Oscillator:

The instrument can be used as a sine wave oscillator as outlined below.

- 1.1 Since the unit features low distortion factor, it can be used for measurement of distortion characteristic of amplifier.
- 1.2 Since the unit features wide bandwidth, it can be used for measurement of frequency characteristic of amplifier.
- 1.3 The built-in high accuracy attenuator permits measurement of amplifier gain.
- 1.4 Can be used as a signal source of impedance bridge.

### 2. Measurement of Amplifier Gain

An example of measurement of amplifier gain is described below. First connect the instrument, amplifier to be tested and AC volt-meter as shown in Fig.4.

- 2.1 Adjust ATTENUATOR (3) and AMPLITUDE (7) so that AC volt-meter indicates the rated output (supposed to be 1V in this example) of the amplifier. To facilitate the measurement, it is advisable to set ATTENUATOR (3) as low as possible. Assume that ATTENUATOR (3) is set -50dB for the rated output.

2.2 Disconnect the amplifier and connect the AC volt-meter to instrument to measure the output voltage.

Note: that the use of ATTENUATOR (3) eliminates the need for connecting a high sensitivity voltmeter. If ATTENUATOR (3) is set to 0dB and the volt-meter indicates 2V, it means that the input voltage of the amplifier is 50dB below 2V. Therefore, the gain obtained is as follows:

$$\begin{aligned} & 50\text{dB} + 20 \log(1\text{V}/2\text{V}) \text{ dB} \\ &= 50\text{dB} - 6\text{dB} \\ &= 44\text{dB} \end{aligned}$$

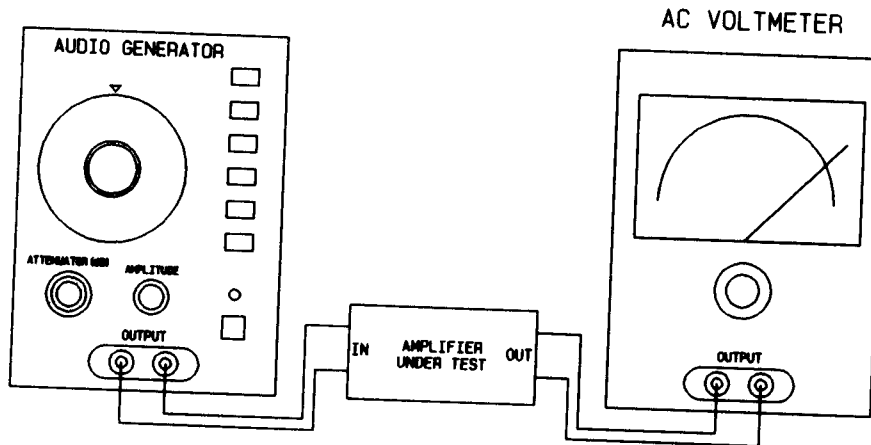

Fig.4

### 3. Measurement of Phase Characteristic

Connect the instrument and an oscilloscope to the amplifier to be tested as shown in Fig. 5. If there is no phase shift about the output signal of the amplifier, the oscilloscope will display a straight line as shown in Fig. 5A. If the straight line on the oscilloscope is curved at its top and bottom

sections as shown in Fig. 5B, it indicates that the output signal of amplifier is suffering from an amplitude distortion. In this case, reduce the output level of instrument a little to vary the frequency. This causes the straight line on the oscilloscope to expand gradually to turn into an ellipse. By utilizing the configuration of this ellipse, the phase shift can be calculated as follows:

First, measure the maximum horizontal deflection and suppose that this deflection is "X" and that the section at which the ellipse crosses the horizontal axis is "x", as shown in Fig. 6. And, the phase shift angle  $\theta$  is given by the following.:

$$\sin \theta = x/X$$

Find  $\theta$  from the table of trigonometric functions and the value obtained gives the angle of phase shift.

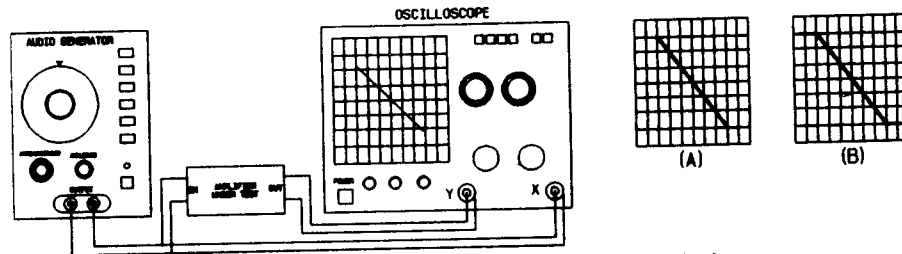

Fig. 5 Measurement of Phase Characteristic

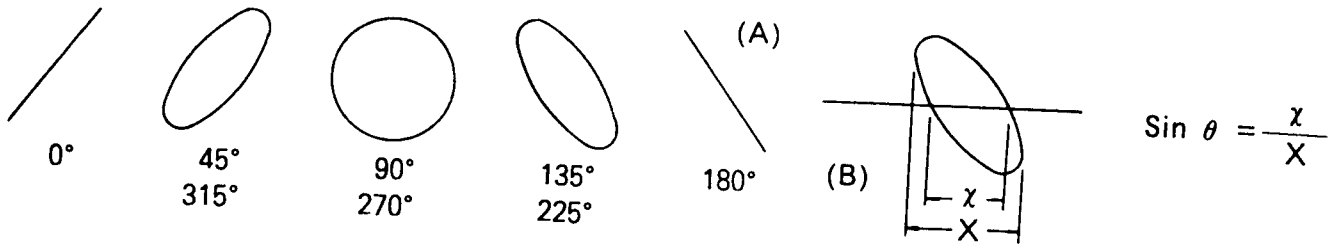

Fig.6 Check of Phase Shift Angle

#### 4. Using as Square Wave Oscillator

The instrument features excellent rising and falling characteristics (120 ns as standard characteristic). It has no coupling capacitors in the output stage, so the sag (deflection of top section) is as low as 5 % at 50Hz. By applying such a good square wave to an amplifier input, various characteristics of amplifier can be observed on an oscilloscope. To test an amplifier proceed as follows:

- 4.1 Connect the instrument, an amplifier to be tested and an oscilloscope as shown in Fig.7.
- 4.2 Press WAVE FORM (5) to the "□" position to obtain square waves of appropriate frequency and amplitude.
- 4.3 During the test, change the frequency as necessary. The relationship between waveforms and amplifier characteristics is shown in Fig.8.

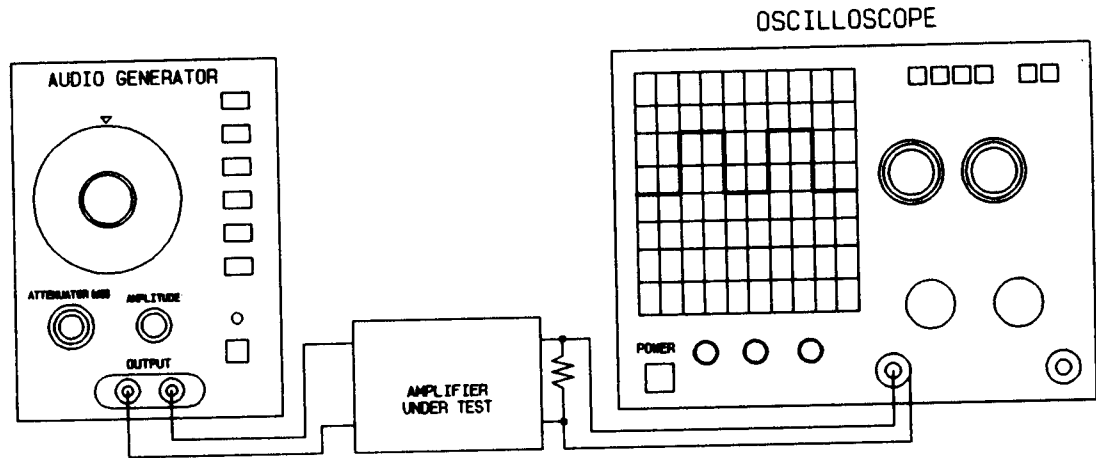

Fig.7









Output waveform	Amplifier characteristic	
	Flat frequency characteristic over 10 times the input frequency	
	Frequency of about 10 times the input frequency is cut off.	
	Frequency of about 1/10 of the input frequency is cut off.	
	Peak appears on frequency of about 10 times the input frequency.	

Fig.8

## 7. ADJUSTMENT AND CALIBRATION

### 1. Oscillating Voltage Adjustment

1.1 Set the instrument frequency to 1KHz. Connect an oscilloscope to TP202.

1.2 Adjust VR201 to obtain a symmetric sine wave on the oscilloscope.

1.3 Adjust VR203 until the sine wave amplitude is 11V p-p.

1.4 Set the instrument frequency to 1MHz. Adjust VC202 until the sine wave amplitude is 12V p-p.

### 2. Frequency Adjustment

2.1 Connect a frequency counter to the OUTPUT terminal.

2.2 Set the FREQ. RANGE switch to  $\times 100$  and the frequency dial to "100" position. Adjust VC203 for 10KHz on the frequency counter.

2.3 Set the frequency dial to "10" position. Adjust VC204 for 1KHz on the frequency counter.

2.4 Repeat step 2.2 and step 2.3.

2.5 Set the FREQ. RANGE switch to  $\times 10K$  and the frequency dial to "100" position. Adjust VC201 for 1MHz on the frequency counter.

### 3. Output DC Voltage Adjustment

3.1 Connect an oscilloscope to the OUTPUT terminal and set the AMPLITUDE knob to "MIN".

3.2 Adjust VR401 to obtain a minimum DC voltage.

#### **4. Distortion Adjustment**

**4.1 Connect a distortion meter to the OUTPUT terminal.**

**4.2 Set the FREQ. RANGE switch to  $\times 100$  and the frequency dial to "10" position.**

**4.3 Adjust VR202 to obtain a minimum distortion.**



## 8. CAUTION

1. Do not apply voltage of more than 10V rms to OUTPUT terminal and SYNC terminal. If a DC voltage is to be used, it should be applied through a capacitor.
2. Connecting leads should be as short as possible. Use of a long shield cable will affect high frequency amplitude characteristics because of its own line capacitance. Also, use of a long unshielded lead will introduce noise and cause other troubles.

### 3. Power supply voltage:

The instrument is preset to the operating voltage, however, this should be checked before connecting AC power cord. Note that operating voltage is within  $\pm 10\%$  of the rated voltage.

### 4. Output waveform after switching on:

Because of the use of direct coupled circuits throughout the entire stage, a DC voltage will appear at OUTPUT terminal for a while when the power is on. This DC voltage will disappear about 20 to 30 seconds later when normal output waveform is obtained.

### 5. Output voltage variation due to ambient temperature:

A thermistor is used to control the oscillating voltage. Care should be used when operating instrument in atmosphere of excessive temperature variation because the thermistor is normally affected by ambient temperature variation.

6. Be sure to press only one **FREQ. RANGE** switch. If two switches are pressed at the same time or all the switches are in released positions, your instrument will not work properly.

7. **Impedance matching:**

Any related equipment to be connected to **OUTPUT** terminal should be checked to see that its input impedance matches the output impedance ( $600 \Omega$ ) of instrument.

8. **Effect of external noise:**

Excessive noise from an outside source may affect the external synchronizing input terminal. If such a noise is evident, short this terminal (output voltage amplitude will somewhat deviate in this case).

## EC Declaration of Conformity

We

**GOOD WILL INSTRUMENT CO., LTD.**

(1) No. 7-1, Jhongsing Road, Tucheng Dist., New Taipei City 236, Taiwan

(2) No.69 Lushan Road, SND, Suzhou Jiangsu 215011 China

declare that the below mentioned product

**GAG-809, GAG-810**

are herewith confirmed to comply with the requirements set out in the Council Directive on the Approximation of the Law of Member States relating to Electromagnetic Compatibility (**2004/108/EC**) and Low Voltage Equipment Directive (**2006/95/EC**).

For the evaluation regarding the Electromagnetic Compatibility and Low Voltage Equipment Directive, the following standards were applied:

EN 61326-1: 2013 EN 61326-2-1: 2013	<b>Electrical equipment for measurement, control and laboratory use — EMC requirements (2013)</b>		
Conducted & Radiated Emission	EN 55011: 2009+A1: 2010 Class B	Electrostatic Discharge	EN 1000-4-2: 2009
		Radiated Immunity	EN 1000-4-3: 2006+A1:2008 +A2: 2010
Current Harmonics	EN 61000-3-3: 2006+A1: 2009 +A2: 2009	Electrical Fast Transients	EN 1000-4-4: 2012
Voltage Fluctuations	EN 61000-3-3: 2008	Surge Immunity	EN 61000-4-5: 2006
-----	-----	Conducted Susceptibility	EN 61000-4-6: 2009
-----	-----	Power Frequency Magnetic field	EN 61000-4-8: 2010
-----	-----	Voltage Dip/Interruption	EN 61000-4-11: 2004

**Low Voltage Equipment Directive 2006/95/EC**

**Low Voltage Directive**

EN 61010-1: 2010 (Third Edition)