

NOTE-DRIVE ARRANGEMENT FOR HD & IG 32 PLANETARY GEARED MOTOR AND MODIFIED HD WHEEL, OMNI WHEELS, MECANUM WHEELS

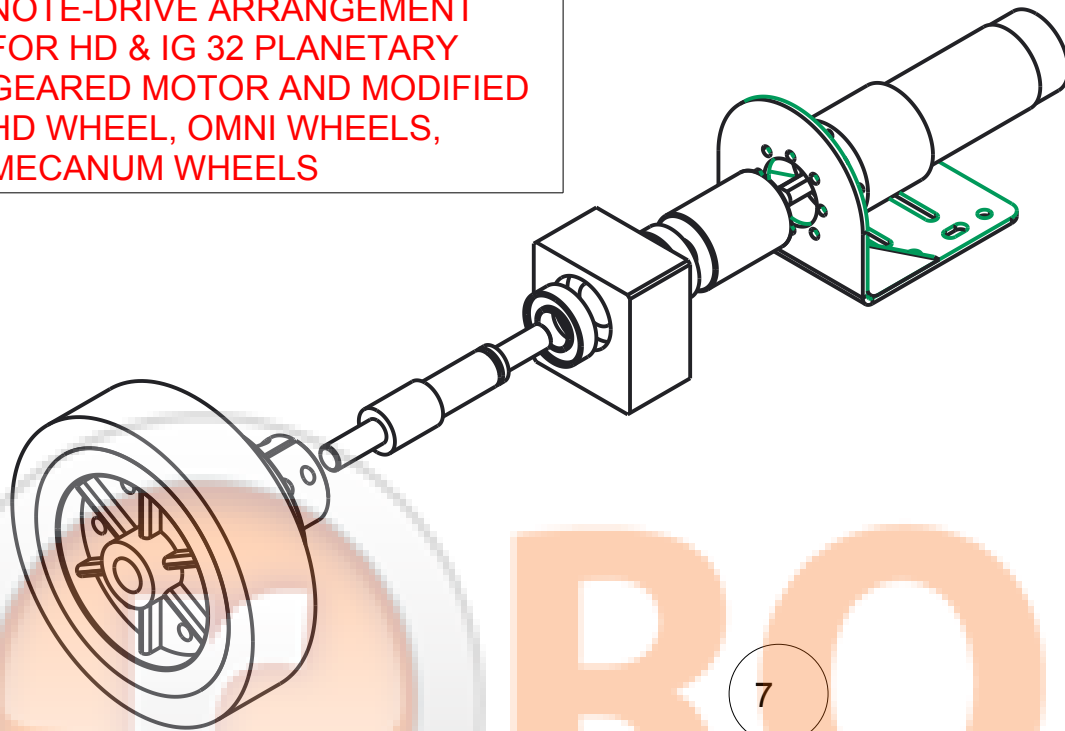

ITEM NO	PART NUMBER	QTY
1	ANTISLIP_COUPLING_8MM	1
2	BEARING	2
3	FLEXIBLE-COUPLING-8X8	1
4	HD-IG-32-MOTOR	1
5	HD-IG-32-MOTOR-BRACKET	1
6	MODIFIED-HD-WHEEL	1
7	MS-SHAFT	1
8	UNIVERSAL-BEARING-HOUSING	1

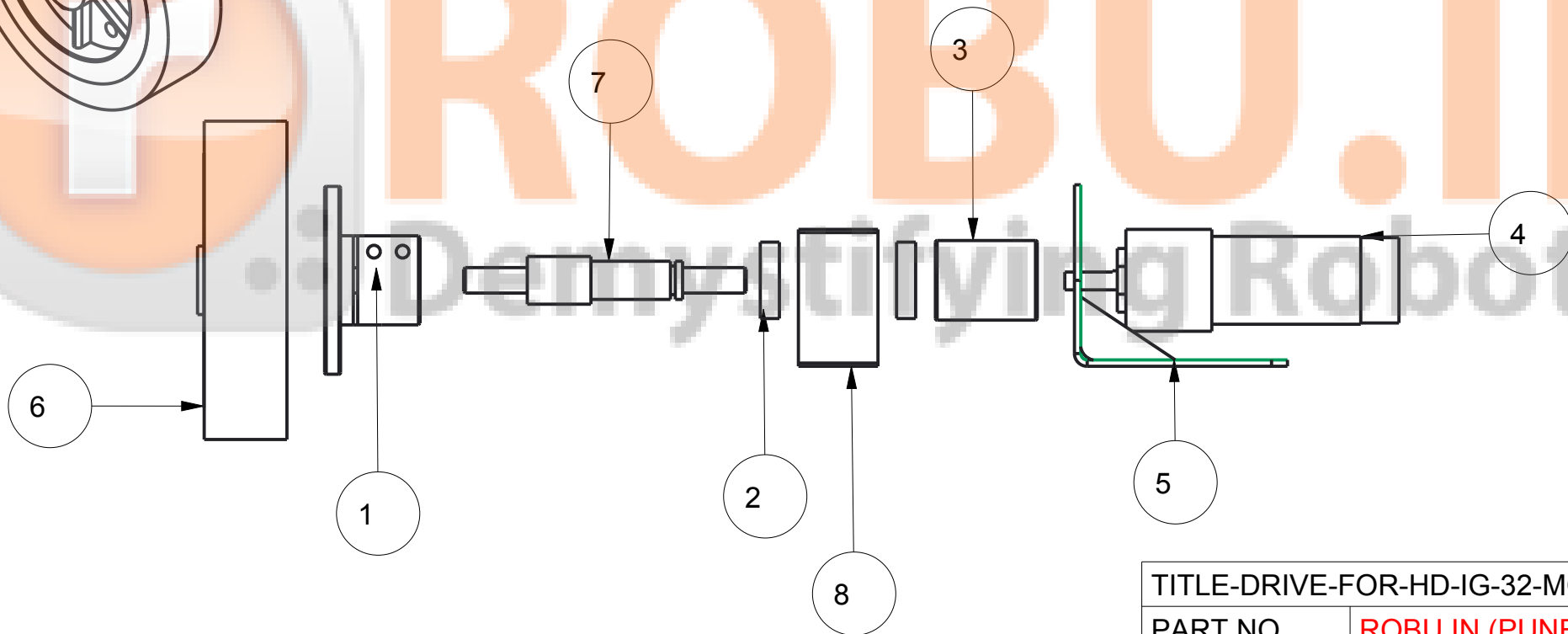

TITLE-DRIVE-FOR-HD-IG-32-MOTOR

PART NO. **ROBU.IN (PUNE)**

SCALE-1:1 DATE-

ALL DIMENSIONS ARE IN MM