

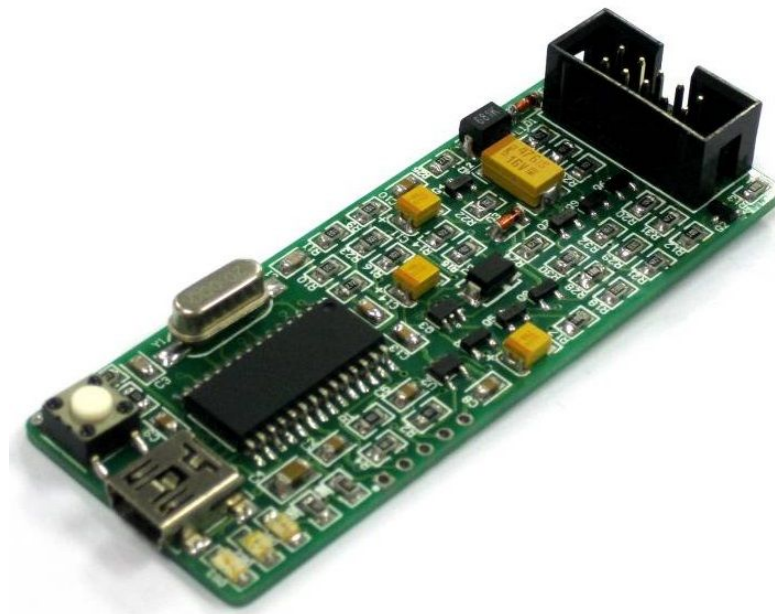

UIC00B
USB ICSP PIC PROGRAMMER



User's Manual

V1.1

June 2015

Information contained in this publication regarding device applications and the like is intended through suggestion only and may be superseded by updates. It is your responsibility to ensure that your application meets with your specifications. No representation or warranty is given and no liability is assumed by Cytron Technologies Incorporated with respect to the accuracy or use of such information or infringement of patents or other intellectual property rights arising from such use or otherwise. Use of Cytron Technologies's products as critical components in life support systems is not authorized except with express written approval by Cytron Technologies. No licenses are conveyed, implicitly or otherwise, under any intellectual property rights.

Index

1. Introduction and Overview	3
2. Packing List	4
3. Supported PIC	5
4. Dimension	10
5. Board Layout	11
6. Hardware	14
6.1 Using UIC00B with application circuit (development board)	14
6.2 Using UIC00B with UIC-S (optional, buy separately)	15
6.2.1 Plugging the microcontroller	18
7. Software	20
7.1 Download setup file from Cytron's website	20
7.2 PICkit 2 Programmer setup procedures	20
7.3 Using PICkit 2 Programmer	24
7.4 PICkit 2 UART TOOL	29
7.4.1 ASCII Mode	31
7.4.2 Hex Mode	32
7.5 PICkit 2 Logic Tool	33
7.5.1 Logic I/O Mode	34
7.5.2 Logic Analyzer Mode	37
8. Getting Started	42
8.1 Using UIC00B with application circuit (development board)	42
8.2 Using UIC00B with UIC-S (optional, buy separately)	44
9. Troubleshooting	45
10. Warranty	46

1. INTRODUCTION/OVERVIEW

[UIC00B](#) is an enhanced version of UIC00A. It offers low cost yet reliable and user friendly PIC USB programmer solutions for developer, hobbyist as well as students. It is designed to program popular Flash PIC MCU which includes most of the PIC family. Besides 8bit, it can also program 16bit and 32bit PIC MCU. On board ICSP™ (In Circuit Serial Programming) connector offers flexible methods to load program, UART Tool and Logic Tool. It supports on board programming which eliminate the frustration of plug-in and plug-out of PIC MCU. This also allow user to quickly program and debug the source code while the target PIC is on the development board. Since USB port is commonly available and widely used on Laptop and Desktop PC, UIC00B is designed to be plug and play with USB connection. This programmer obtained its power directly from USB connection, thus **NO external power supply** is required, making it a truly portable programmer. This programmer is ideal for field and general usage. UIC00B offers reliable, high speed programming and free windows interface software.

- **New!** Program most of the +3.3V or +5V PIC.
- **New!** Compatible with PICKit2's UART Tool and Logic Tool.
- **New!** Program most of the current 8-, 16-, and 32-bit Flash PIC microcontroller.

It is designed with capabilities and features of:

- Industrial grade PCB with surface mount component to offer small size yet reliable and quality product.
- Every component is soldered properly and programmer is tested before it is shipped to customer.
- USB Plug and Play function.
- IDC box header for ICSP™ connection, an IDC cable is included for external on board programming.
- Windows XP compatible software.
- **Compatible with Windows XP, Vista, Win 7, Win 8 & 8.1 (32-bit or 64-bit) .**
- Auto load program capability.
- Compatible with Microchip's PICKit 2.
- Integrated into MPLAB IDE or MPLAB X IDE as PICKit2, just 1 software to develop, compile and load program.
- Powered directly from USB port.
- **NO EXTERNAL POWER REQUIRED for UIC00B to function.**
- USB 2.0
- Low cost yet reliable solution.
- Suitable for Laptop and Desktop PC.
- Optional socket (UIC-S) to program 18 pins, 28 pins and 40 pins PIC microcontroller.
- **Dimension** 74mm x 28mm

This document explains the method to use UIC00B.

2. PACKING LIST

Please check the parts and components according to the packing list. If there are any parts missing, please contact us at sales@cytron.com.my immediately.

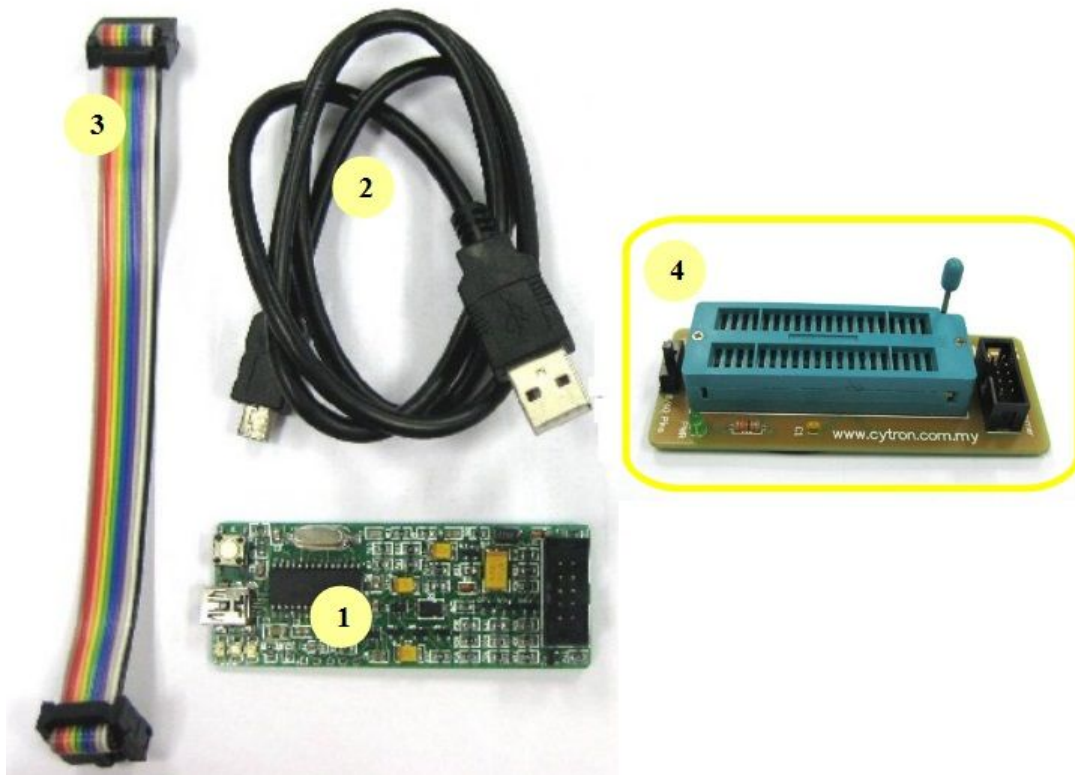

1. 1 x [UIC00B](#) main board
2. 1 x [mini USB cable](#)
3. 1 x rainbow cable <http://cytron.com.my/p-wr-uic> (programming cable)
4. 1 x [UIC-S socket board](#) (optional, buy separately from Cytron website)

3. SUPPORTED PIC

Please refer PICkit 2 Readme file for supported PIC. The file can be downloaded at the [UIC00B](#) product page, under “Attachment” tab. We can only listed those popular model.

Baseline Devices

PIC10F200	PIC10F202	PIC10F204	PIC10F206
PIC10F220	PIC10F222		
PIC12F508	PIC12F509	PIC12F510	PIC12F519
PIC16F505	PIC16F506	PIC16F526	
PIC16F54	PIC16F57	PIC16F59	

Midrange/Standard Devices

>> All 'LF' versions of devices are supported

PIC12F609	PIC12HV609		
PIC12F615	PIC12HV615		
PIC12F629	PIC12F635#	PIC12F675	PIC12F683#
PIC16F610	PIC16HV610	PIC16F616	PIC16HV616
PIC16F627	PIC16F628	PIC16F639	
PIC16F627A	PIC16F628A	PIC16F648A	
PIC16F630	PIC16F631	PIC16F636#	PIC16F676
PIC16F677	PIC16F684#	PIC16F685#	PIC16F687#
PIC16F688#	PIC16F689#	PIC16F690#	
PIC16F72+			
PIC16F73+	PIC16F74+	PIC16F76+	PIC16F77+
PIC16F716			
PIC16F737+	PIC16F747+	PIC16F767+	PIC16F777+
PIC16F785	PIC16HV785		
PIC16F84A	PIC16F87#	PIC16F88#	
PIC16F818#	PIC16F819#		
PIC16F870	PIC16F871	PIC16F872	
PIC16F873	PIC16F874	PIC16F876	PIC16F877
PIC16F873A	PIC16F874A	PIC16F876A	PIC16F877A
PIC16F882#			
PIC16F883#	PIC16F884#	PIC16F886#	PIC16F887#
PIC16F913#	PIC16F914#	PIC16F916#	PIC16F917#
PIC16F946#			

Midrange/1.8V Min Devices

PIC16F722	PIC16LF722		
PIC16F723	PIC16LF723	PIC16F724	PIC16LF724
PIC16F726	PIC16LF726	PIC16F727	PIC16LF727
PIC16F1933	PIC16F1934	PIC16F1936	PIC16F1937
PIC16F1938	PIC16F1939		
PIC16LF1933	PIC16LF1934	PIC16LF1936	PIC16LF1937
PIC16LF1938	PIC16LF1939		

PIC18F Devices

>> All 'LF' versions of devices are supported

PIC18F242	PIC18F252	PIC18F442	PIC18F452
PIC18F248	PIC18F258	PIC18F448	PIC18F458
PIC18F1220	PIC18F1320	PIC18F2220	
PIC18F1230	PIC18F1330	PIC18F1330-ICD	
PIC18F2221	PIC18F2320	PIC18F2321	PIC18F2331
PIC18F2410	PIC18F2420	PIC18F2423	PIC18F2431
PIC18F2450	PIC18F2455	PIC18F2458	PIC18F2480
PIC18F2510	PIC18F2515	PIC18F2520	PIC18F2523
PIC18F2525	PIC18F2550	PIC18F2553	PIC18F2580
PIC18F2585			
PIC18F2610	PIC18F2620	PIC18F2680	PIC18F2682
PIC18F2685			
PIC18F4220	PIC18F4221	PIC18F4320	PIC18F4321
PIC18F4331	PIC18F4410	PIC18F4420	PIC18F4423
PIC18F4431	PIC18F4450	PIC18F4455	PIC18F4458
PIC18F4480			
PIC18F4510	PIC18F4515	PIC18F4520	PIC18F4523
PIC18F4525	PIC18F4550	PIC18F4553	PIC18F4580
PIC18F4585			
PIC18F4610	PIC18F4620	PIC18F4680	PIC18F4682
PIC18F4685	PIC18F6310	PIC18F6390	PIC18F6393
PIC18F6410	PIC18F6490	PIC18F6493	PIC18F6520
PIC18F6525	PIC18F6527		
PIC18F6585	PIC18F6620	PIC18F6621	PIC18F6622
PIC18F6627	PIC18F6628	PIC18F6680	PIC18F6720
PIC18F6722	PIC18F6723		
PIC18F8310	PIC18F8390	PIC18F8393	PIC18F8410
PIC18F8490	PIC18F8493		
PIC18F8520	PIC18F8525	PIC18F8527	PIC18F8585
PIC18F8620	PIC18F8621	PIC18F8622	PIC18F8627
PIC18F8628			
PIC18F8680	PIC18F8720	PIC18F8722	PIC18F8723

PIC18F_J_ Devices

PIC18F24J10	PIC18LF24J10		
PIC18F24J11	PIC18LF24J11	PIC18F24J50	PIC18LF24J50
PIC18F25J10	PIC18LF25J10		
PIC18F25J11	PIC18LF25J11	PIC18F25J50	PIC18LF25J50
PIC18F26J11	PIC18LF26J11	PIC18F26J50	PIC18LF26J50
PIC18F44J10	PIC18LF44J10		
PIC18F44J11	PIC18LF44J11	PIC18F44J50	PIC18LF44J50
PIC18F45J10	PIC18LF45J10		
PIC18F45J11	PIC18LF45J11	PIC18F45J50	PIC18LF45J50
PIC18F46J11	PIC18LF46J11	PIC18F46J50	PIC18LF46J50
PIC18F63J11	PIC18F63J90	PIC18F64J11	PIC18F64J90
PIC18F65J10	PIC18F65J11	PIC18F65J15	PIC18F65J50
PIC18F65J90			

PIC18F66J10	PIC18F66J11	PIC18F66J15	PIC18F66J16
PIC18F66J50	PIC18F66J55	PIC18F66J60	PIC18F66J65
PIC18F66J90			
PIC18F67J10	PIC18F67J11	PIC18F67J50	PIC18F67J60
PIC18F67J90			
PIC18F83J11	PIC18F83J90	PIC18F84J11	PIC18F84J90
PIC18F85J10	PIC18F85J11	PIC18F85J15	PIC18F85J50
PIC18F85J90			
PIC18F86J10	PIC18F86J11	PIC18F86J15	PIC18F86J16
PIC18F86J50	PIC18F86J55	PIC18F86J60	PIC18F86J65
PIC18F86J90			
PIC18F87J10	PIC18F87J11	PIC18F87J50	PIC18F87J60
PIC18F87J90			
PIC18F96J60	PIC18F96J65	PIC18F97J60	

PIC18F_K_Devices

PIC18F13K22	PIC18LF13K22	PIC18F14K22	PIC18LF14K22
PIC18F13K50	PIC18LF13K50	PIC18F14K50	PIC18LF14K50
PIC18F14K50-ICD			
PIC18F23K20	PIC18F24K20	PIC18F25K20	PIC18F26K20
PIC18F43K20	PIC18F44K20	PIC18F45K20	PIC18F46K20

PIC24 Devices

PIC24F04KA200	PIC24F04KA201
PIC24F08KA101	PIC24F08KA102
PIC24F16KA101	PIC24F16KA102

NOTE: To program PIC24F-KA- devices with MCLR used as IO, Tools > Use High Voltage Program Entry must be enabled.

PIC24FJ16GA002	PIC24FJ16GA004
PIC24FJ32GA002	PIC24FJ32GA004
PIC24FJ32GA102	PIC24FJ32GA104
PIC24FJ48GA002	PIC24FJ48GA004
PIC24FJ64GA002	PIC24FJ64GA004
PIC24FJ64GA102	PIC24FJ64GA104

PIC24FJ64GA006	PIC24FJ64GA008	PIC24FJ64GA010
PIC24FJ96GA006	PIC24FJ96GA008	PIC24FJ96GA010
PIC24FJ128GA006	PIC24FJ128GA008	PIC24FJ128GA010
PIC24FJ128GA106	PIC24FJ128GA108	PIC24FJ128GA110
PIC24FJ192GA106	PIC24FJ192GA108	PIC24FJ192GA110
PIC24FJ256GA106	PIC24FJ256GA108	PIC24FJ256GA110

PIC24FJ32GB002	PIC24FJ32GB004
PIC24FJ64GB002	PIC24FJ64GB004

PIC24FJ64GB106	PIC24FJ64GB108	PIC24FJ64GB110
PIC24FJ128GB106	PIC24FJ128GB108	PIC24FJ128GB110

PIC24FJ192GB106	PIC24FJ192GB108	PIC24FJ192GB110
PIC24FJ256GB106	PIC24FJ256GB108	PIC24FJ256GB110

PIC24HJ12GP201	PIC24HJ12GP202	
PIC24HJ16GP304		
PIC24HJ32GP202	PIC24HJ32GP204	
PIC24HJ32GP302	PIC24HJ32GP304	
PIC24HJ64GP202	PIC24HJ64GP204	
PIC24HJ64GP206	PIC24HJ64GP210	
PIC24HJ64GP502		
PIC24HJ64GP504	PIC24HJ64GP506	PIC24HJ64GP510
PIC24HJ128GP202	PIC24HJ128GP204	
PIC24HJ128GP206	PIC24HJ128GP210	
PIC24HJ128GP306	PIC24HJ128GP310	
PIC24HJ128GP502	PIC24HJ128GP504	
PIC24HJ128GP506	PIC24HJ128GP510	
PIC24HJ256GP206	PIC24HJ256GP210	PIC24HJ256GP610

dsPIC33 Devices

dsPIC33FJ06GS101	dsPIC33FJ06GS102	dsPIC33FJ06GS202
dsPIC33FJ16GS402	dsPIC33FJ16GS404	
dsPIC33FJ16GS502	dsPIC33FJ16GS504	

dsPIC33FJ12GP201	dsPIC33FJ12GP202	
dsPIC33FJ16GP304		
dsPIC33FJ32GP202	dsPIC33FJ32GP204	
dsPIC33FJ32GP302	dsPIC33FJ32GP304	
dsPIC33FJ64GP202	dsPIC33FJ64GP204	
dsPIC33FJ64GP206	dsPIC33FJ64GP306	dsPIC33FJ64GP310
dsPIC33FJ64GP706	dsPIC33FJ64GP708	dsPIC33FJ64GP710
dsPIC33FJ64GP802	dsPIC33FJ64GP804	
dsPIC33FJ128GP202	dsPIC33FJ128GP204	
dsPIC33FJ128GP206	dsPIC33FJ128GP306	dsPIC33FJ128GP310
dsPIC33FJ128GP706	dsPIC33FJ128GP708	dsPIC33FJ128GP710
dsPIC33FJ256GP506	dsPIC33FJ256GP510	dsPIC33FJ256GP710
dsPIC33FJ128GP802	dsPIC33FJ128GP804	

dsPIC33FJ12MC201	dsPIC33FJ12MC202	
dsPIC33FJ16MC304		
dsPIC33FJ32MC202	dsPIC33FJ32MC204	
dsPIC33FJ32MC302	dsPIC33FJ32MC304	
dsPIC33FJ64MC202	dsPIC33FJ64MC204	
dsPIC33FJ64MC506	dsPIC33FJ64MC508	dsPIC33FJ64MC510
dsPIC33FJ64MC706	dsPIC33FJ64MC710	
dsPIC33FJ64MC802	dsPIC33FJ64MC804	
dsPIC33FJ128MC202	dsPIC33FJ128MC204	
dsPIC33FJ128MC506	dsPIC33FJ128MC510	dsPIC33FJ128MC706
dsPIC33FJ128MC708	dsPIC33FJ128MC710	
dsPIC33FJ256MC510	dsPIC33FJ256MC710	

dsPIC33FJ128MC802 dsPIC33FJ128MC804

dsPIC30 Devices

dsPIC30F2010	dsPIC30F2011	dsPIC30F2012
dsPIC30F3010	dsPIC30F3011	dsPIC30F3012
dsPIC30F3013	dsPIC30F3014	
dsPIC30F4011	dsPIC30F4012	dsPIC30F4013
dsPIC30F5011 [^]	dsPIC30F5013 [^]	dsPIC30F5015
dsPIC30F5016		
dsPIC30F6010A	dsPIC30F6011A	dsPIC30F6012A
dsPIC30F6013A	dsPIC30F6014A	dsPIC30F6015

[^] These 2 devices are not supported for low VDD programming.

dsPIC30 SMPS Devices

dsPIC30F1010
dsPIC30F2020 dsPIC30F2023

PIC32 Devices

PIC32MX320F032H PIC32MX320F064H PIC32MX320F128L
PIC32MX320F128H
PIC32MX340F128H PIC32MX340F128L
PIC32MX340F256H
PIC32MX340F512H*
PIC32MX360F256L PIC32MX360F512L
PIC32MX420F032H
PIC32MX440F128L PIC32MX440F128H
PIC32MX440F256H PIC32MX440F512H
PIC32MX460F256L PIC32MX460F512L

4. DIMENSION

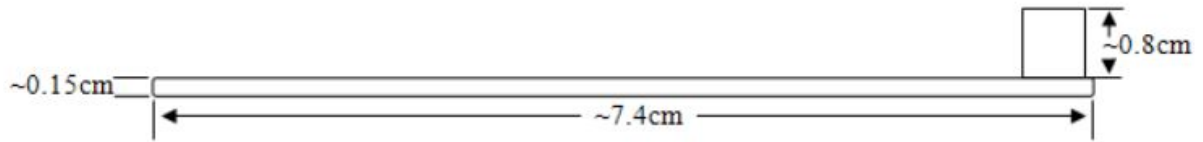

Side View

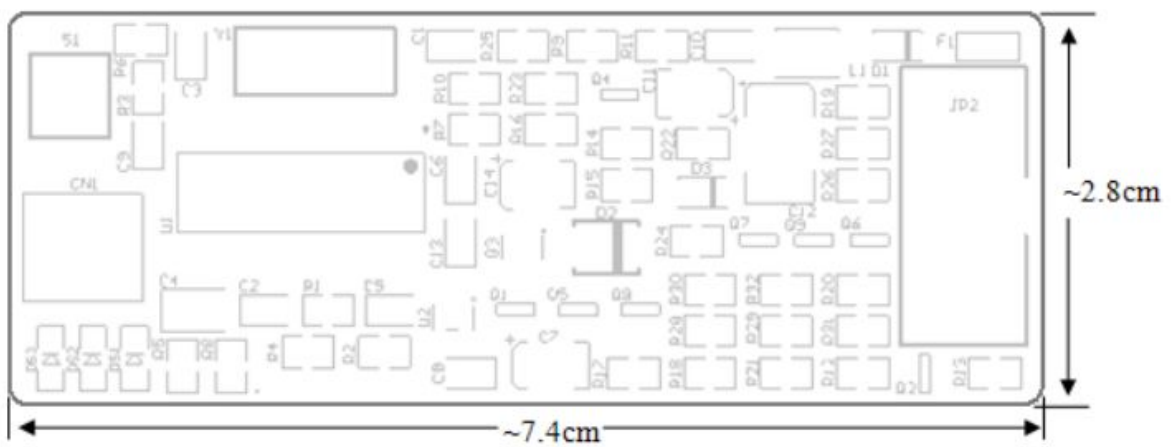

Top View

5. BOARD LAYOUT

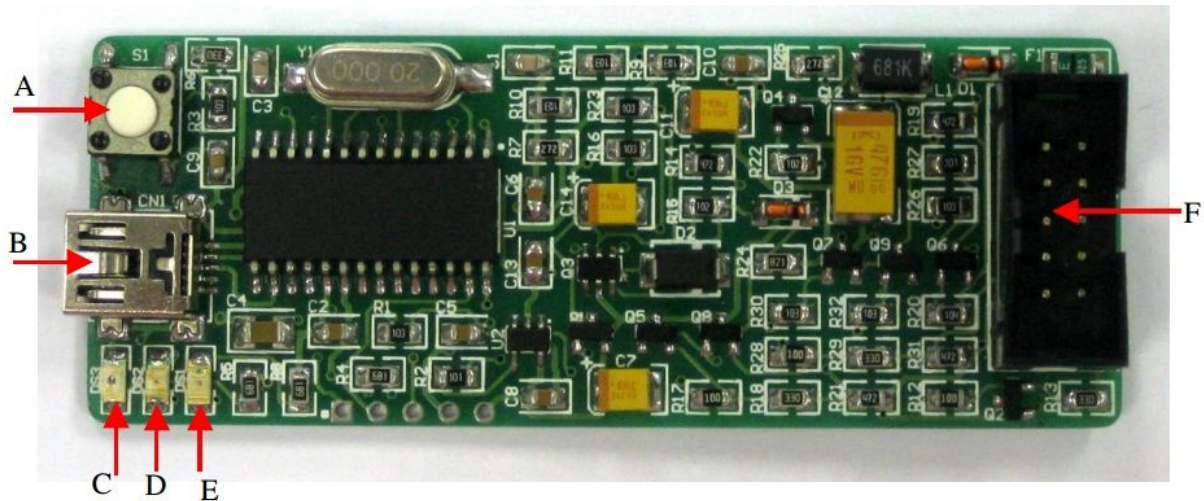

Label	Function
A	Push Button
B	Mini USB port socket
C	Main power supply indicator LED (green)
D	Target indicator LED (orange)
E	Busy indicator LED (red)
F	IDC Box Header for programming connector

Push Button

This push button used to initiate the write device function when *programmer>Write on PICkit Button* is checked.

Mini USB port

This is for USB connection to PC desktop or laptop. Please connect the mini header of USB cable to this socket.

Mini USB socket is not designed for frequent plug in and plug out, thus user is advise to minimize the connect/disconnect of USB cable and Mini USB socket. It is advice to disconnect it at the other end of USB cable which is USB type A. This will pro-long the life span of UIC00B.

Main power supply indicator LED(green)

This LED is to indicate the main power supply of UIC00B. It should ON once USB connection from UIC00B to computer or laptop is ready.

Target indicator LED (orange)

This LED is used to indicate the UIC00B is powering the target device.

Busy indicator LED (red)

This LED is used to indicate busy function such as UIC00B is in program mode or is alerting that a function is in progress.

IDC Box Header for programming connector

This IDC box header is for programming cable. Please connect one end of programming cable to this header, while the other end to target board.

Figure and table below shown UIC00B pin connection and description.

No Pin	UIC00B Pin Description
1	Not connect
2	Not connect
3	Vpp
4	GND
5	ICSP clock/PGC
6	GND
7	ICSP data/PGD
8	VDD
9	Aux_Out
10	Not connect

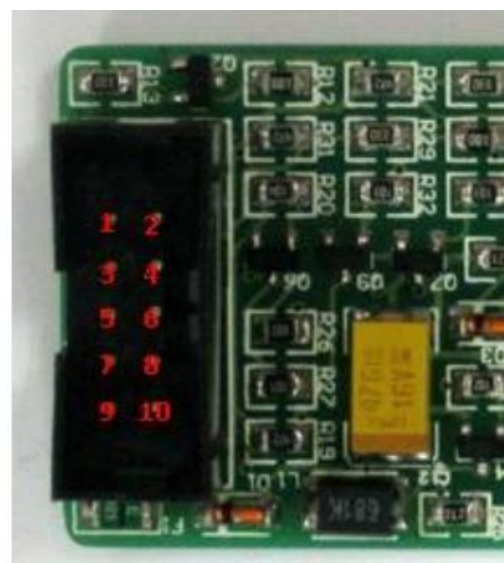

***UIC00B ICSP Programmer Pin**

Figure and table below shown SK40C ICSP Programmer pin connection at the target board

No Pin	Target board Pin Description
1	Not connect
2	Not connect
3	MCLR/Vpp
4	GND
5	ICSP clock/PGC
6	GND
7	ICSP data/PGD
8	Not connect
9	Not connect
10	Not connect



***SK40C target board pin**

6. HARDWARE

This section will show the connection during [UIC00B](#) usage. User may use UIC00B with target/development board or [UIC-S](#). UIC-S is optional and user needs to buy it separately.

6.1 Using UIC00B with application circuit (development board)

1. Connect A-type USB connector (one end of USB cable) to USB port at laptop or PC desktop.



2. Connect another end of USB cable (mini) to UIC00B USB port. Power supply indication green LED will light ON.

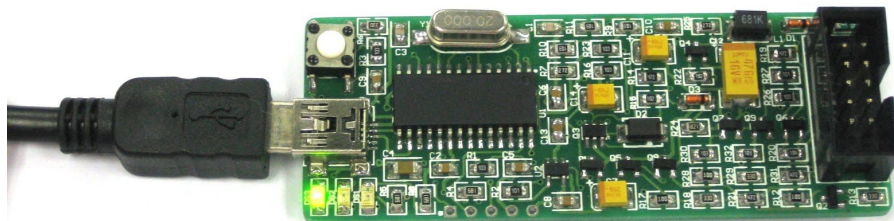

3. Continue to software installation if this is the first time usage. Refer to section 6 for software installation guide.
4. Connect one side of programming cable to box header of UIC00B and the other side to box header of development board (target device) to be programmed. Use external power for the target board, UIC00B cannot support large power usage.

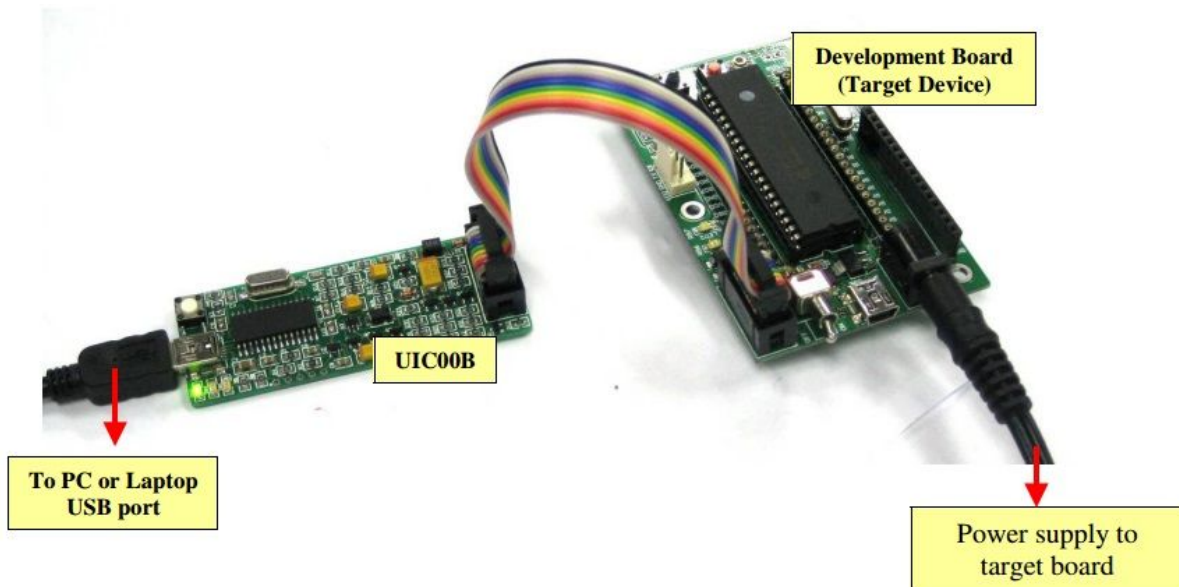

Caution: USB port current limit is 150mA. If the target and UIC00B exceed this current limit, the UIC00B board might be damaged. The target board should be powered externally.

6.2 Using UIC00B with UIC-S (optional, buy separately)

1. Connect A-type USB connector (one end of USB cable) to USB port at laptop or PC desktop.



2. Connect another end of USB cable (mini) to UIC00B USB port.
 - Power supply indication green LED will light ON.

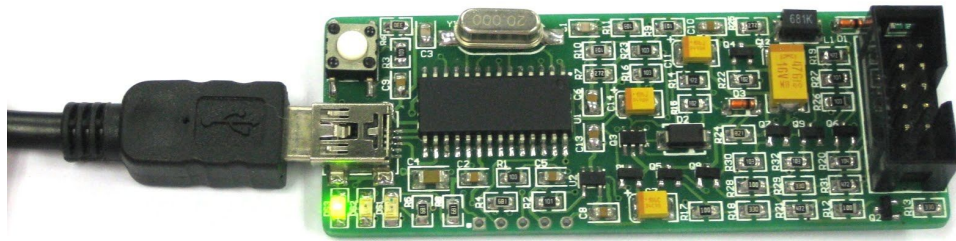

3. Continue to software installation if this is the first time usage. Refer to section 6 for software installation guide.
4. Connect one side of programming cable to box header of UIC00B and the other side to box header of UIC-S board.
 - No external power required for [UIC-S](#) to function.

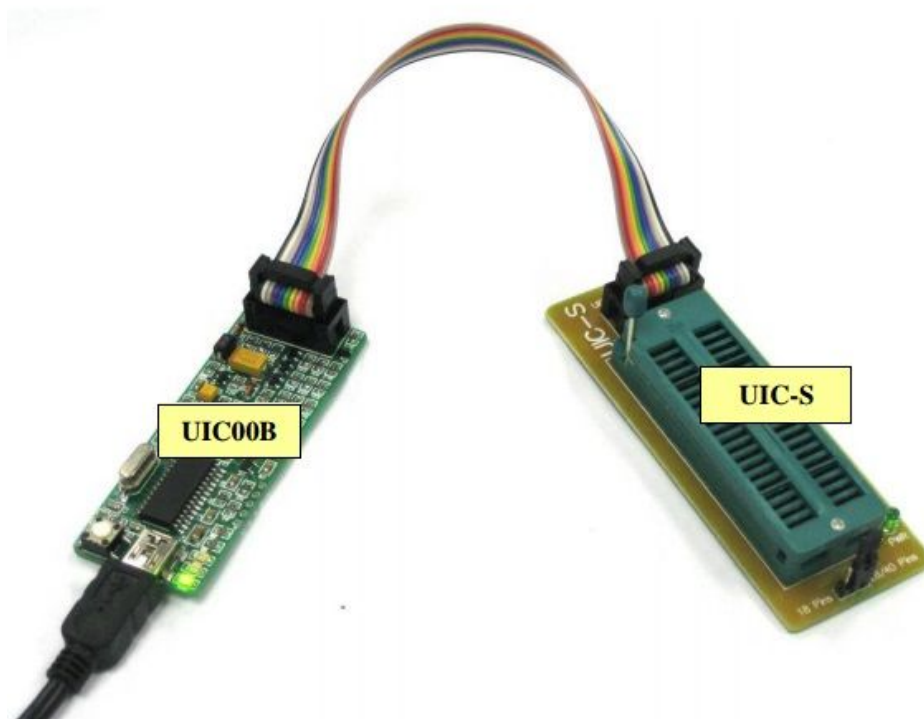

6.2.1 Plugging the microcontroller

40-pin Microcontroller

- Plug in the microcontroller at the ZIF socket and select 40 pins at label “28/40 Pins” using mini jumper as shown below.

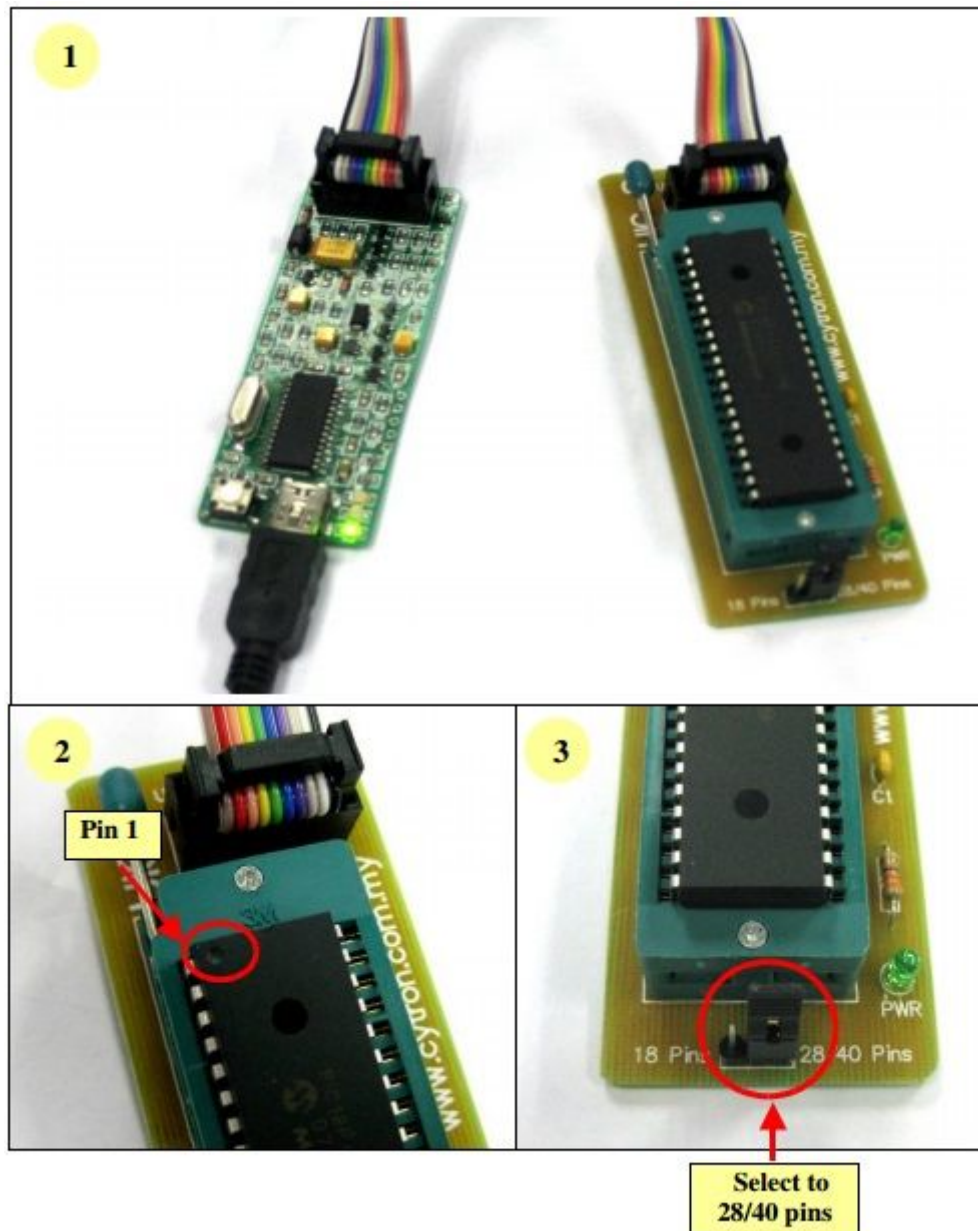

28-pin Microcontroller

- Plug in the microcontroller at the upper portion of the ZIF socket and select 28 pins at label “28/40 Pins” using mini jumper as shown below.

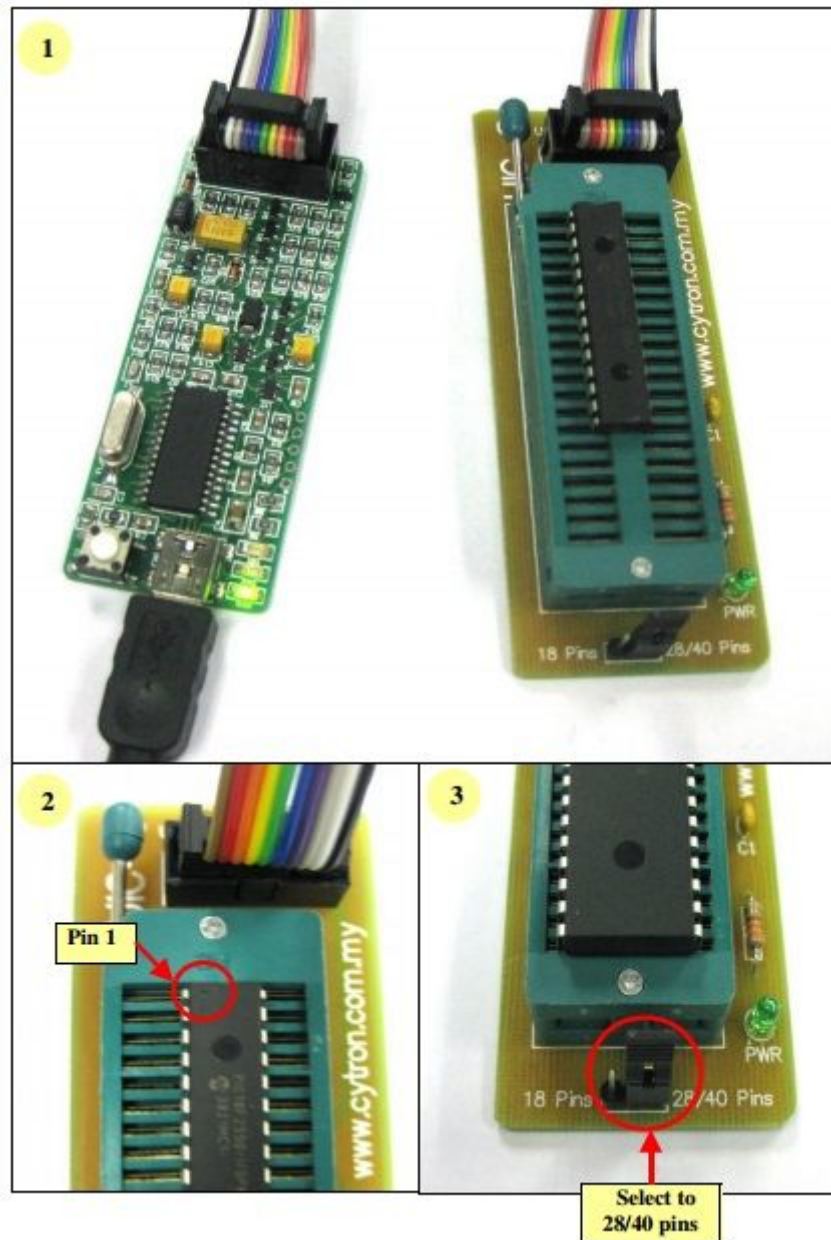

18-pin Microcontroller

- Plug in the microcontroller at the lower portion of the ZIF socket and select 18 pins using mini jumper as shown below.

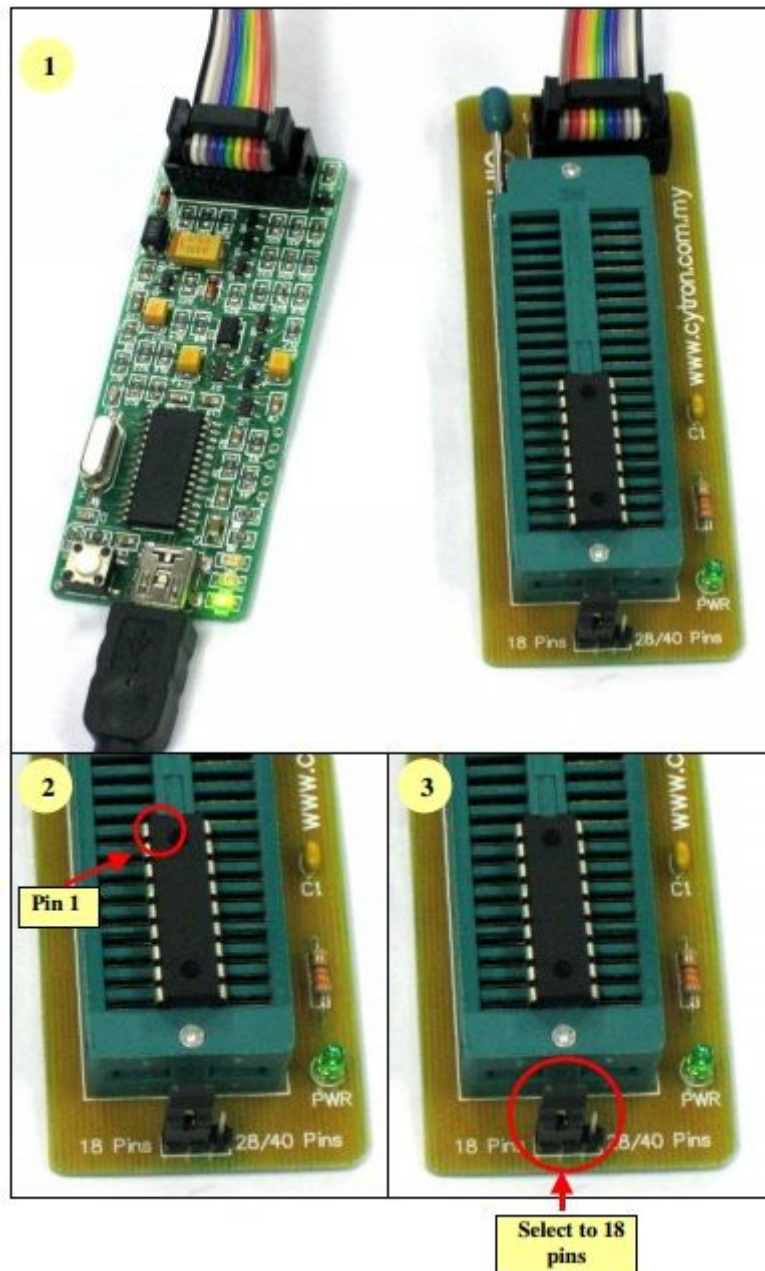

7. SOFTWARE

Since UIC00B is compatible with PICkit 2, thus PICkit 2 programming software should be installed. With the help of pictures and some simple instruction, following section will guide to install the PICkit 2 programming software.

7.1 Download setup file from Cytron's website

1. User may download the setup file from Cytron's website: www.cytron.com.my
2. After finish downloading, unzip the file and click "setup" to run the installation wizard.



7.2 PICkit 2 Programmer setup procedures

Follow steps below to setup Microchip PICkit2 Programmer after launched the setup file.

1. Click next.



- The following window concerns the installation folder. Click *Browse* if you want to change the default destination. Assuming change, click on *Next*.



- Click next to start the installation of the PICkit 2 programming software.

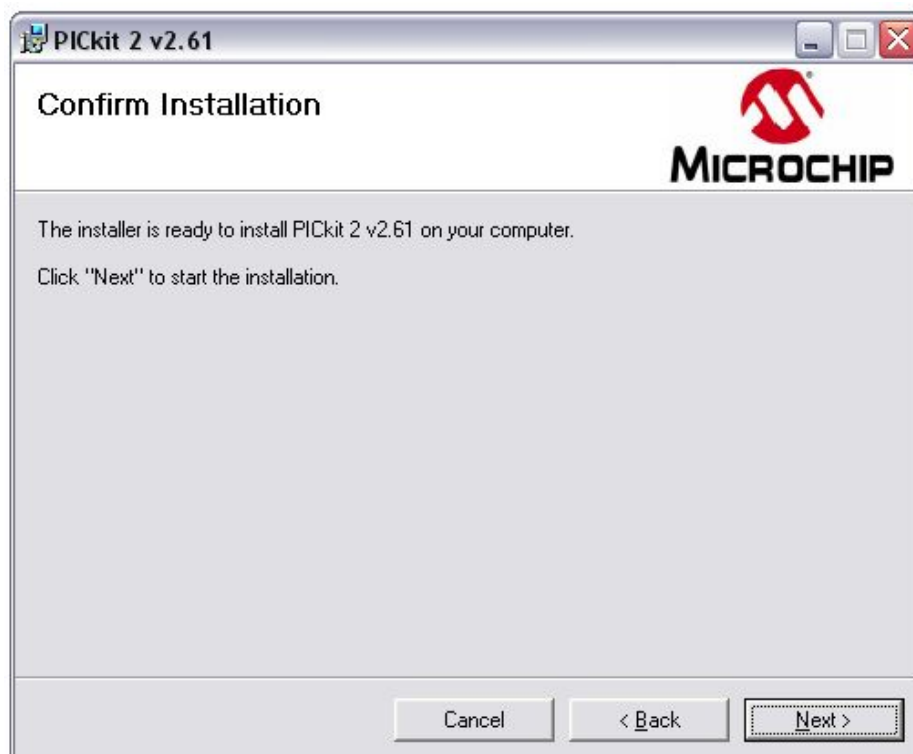

- The following license agreement window will appear. In order to proceed with the installation, read the conditions, select the option *I Agree* and click on *Next*.



- Wait for a while. PICkit 2 is being installed to PC.



6. After complete installation, click Close to exit.



7.3 Using PICKit 2 Programmer

After installing hardware and software in previous section, UIC00B is ready to be used with PICKit 2 programming software. This section gives instruction on how to get started with UIC00B. With the help of pictures and some simple instruction, following section illustrates the steps using UIC00B.

1. Connect the UIC00B as shown in section 5 (hardware installation).
2. Launch PICKit 2 programming software by selecting *Start> Program> Microchip> PICKit 2*.
 - The following programming interface appears and notifies that the PICKit 2 and target device found and connected.
 - This programmer is able to automatically detect PIC from connected target and display it in the *Device Configuration* window.

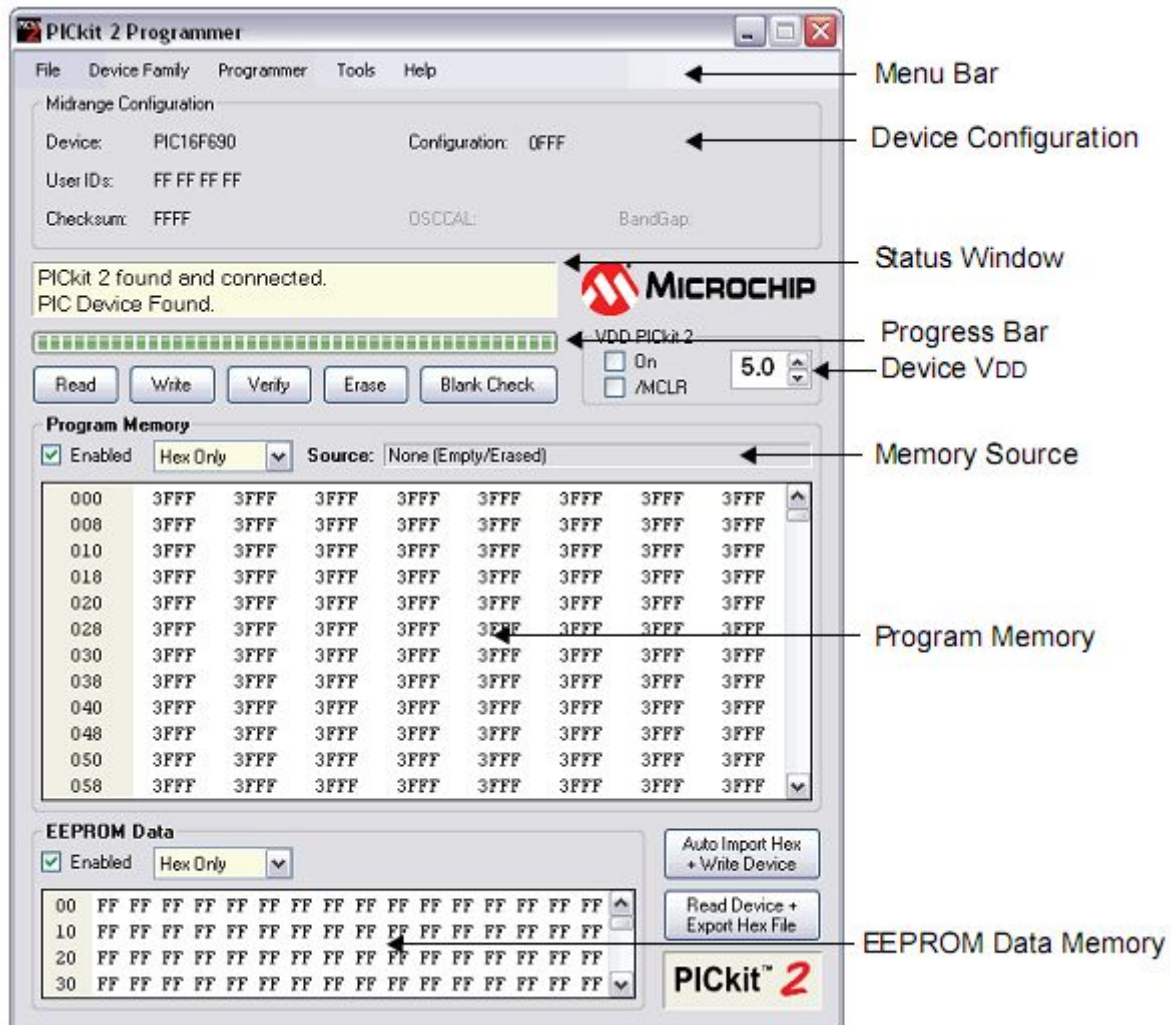

- If PICKit 2 Programmer does not detect the PIC automatically, user needs to help PICKit 2 Programmer to detect it manually. Click Tools and then Check Communication. PICKit 2 Programmer will detect the device and name it.

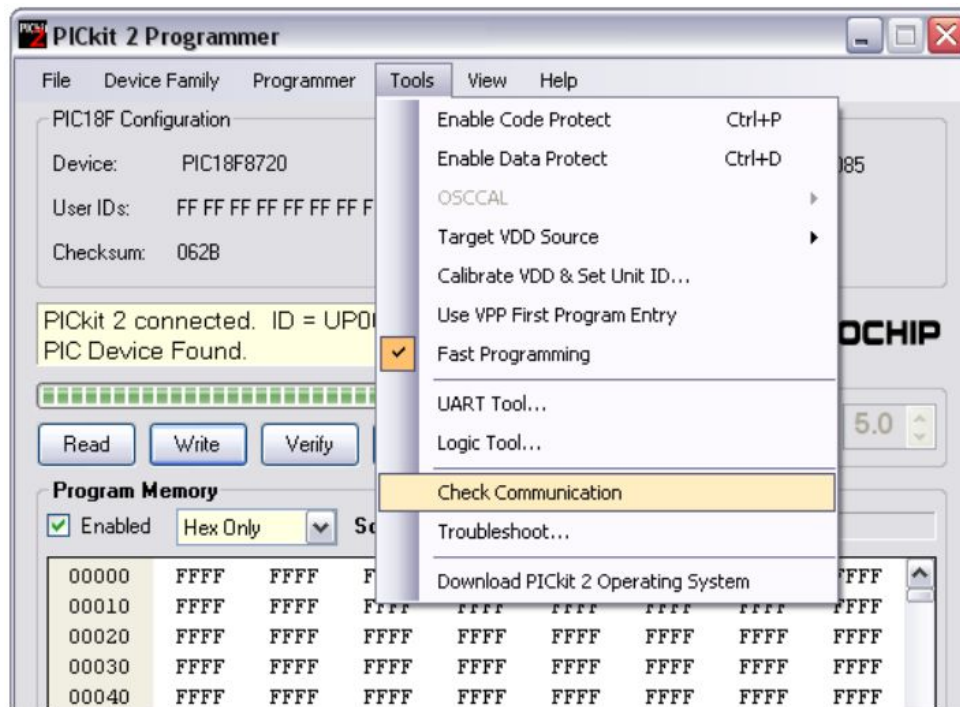

- If device is successfully detected, the device name will appeared at “Device Configuration” area.
3. UIC00B can supply power to the target device for PIC MCU. If users are going to power the target board from the UIC00B, do not attach a power supply to the target board. To supply power to the target device, click checkbox “On”. The voltage may be set in the box on the right either by typing it directly or using the up/down arrows to adjust it a tenth of a volt at a time. The maximum and minimum allowed voltages will vary depending on the target device. If the “On” checkbox is unchecked, PICKit 2 will automatically turn on the VDD at the set voltage during any requested programming operation. Please make sure the VDD of the target device is connected to the programmer if user would like to use this features.

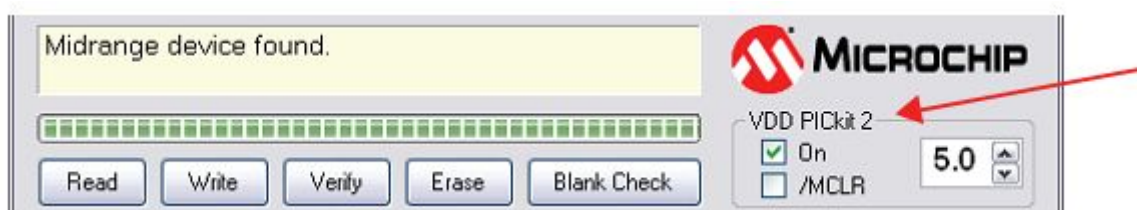

4. Although UIC00B can supply power to PIC on the target device, users are advised to power the target device externally to prevent this programmer exceed from 150mA current limit. If the target device has its own power supply, then the PICKit 2 will display the detected V_{DD} voltage in the box on the right, which will be

grayed out to prevent being changed.



Caution: USB port current limit is 150mA. If the target and UIC00B exceed this current limit, the UIC00B board might be damaged. The target board should be powered externally. If the target device is powered externally, please DONOT connect V_{DD} (5V) of UIC00B to target PIC, only one power supply should be connected to target PIC.

5. Import the Hex file by choosing 'File' and click 'Import Hex'.

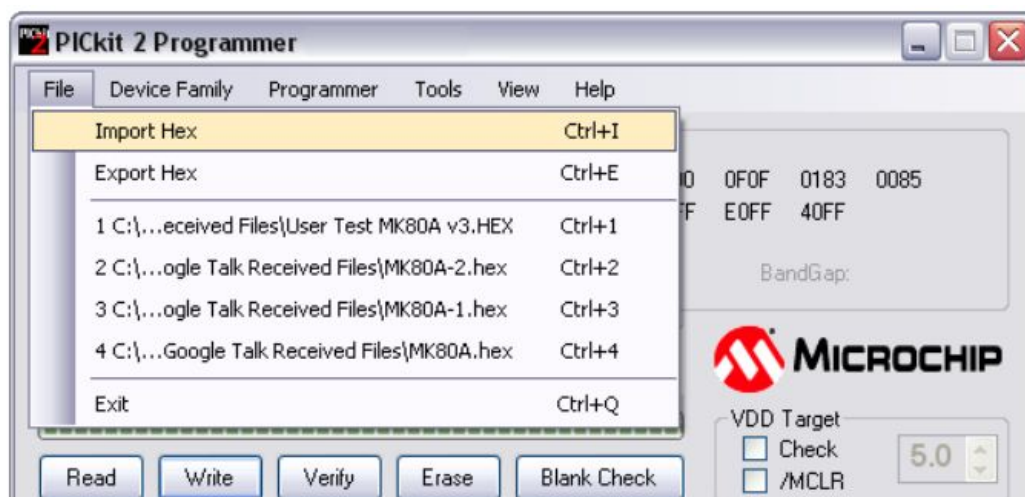

6. Browse for the hex file and click Open. The code is displayed in the Program Memory and EEPROM Data windows. The name of the hex file is displayed in the Source Block under Program Memory. Hex file generated from MPLAB IDE will be named according to project name, not C file name.
7. After a device family has been selected and a hex file has been imported, the target device can be programmed by clicking Write. The device will be erased and programmed with the hex code previously imported.

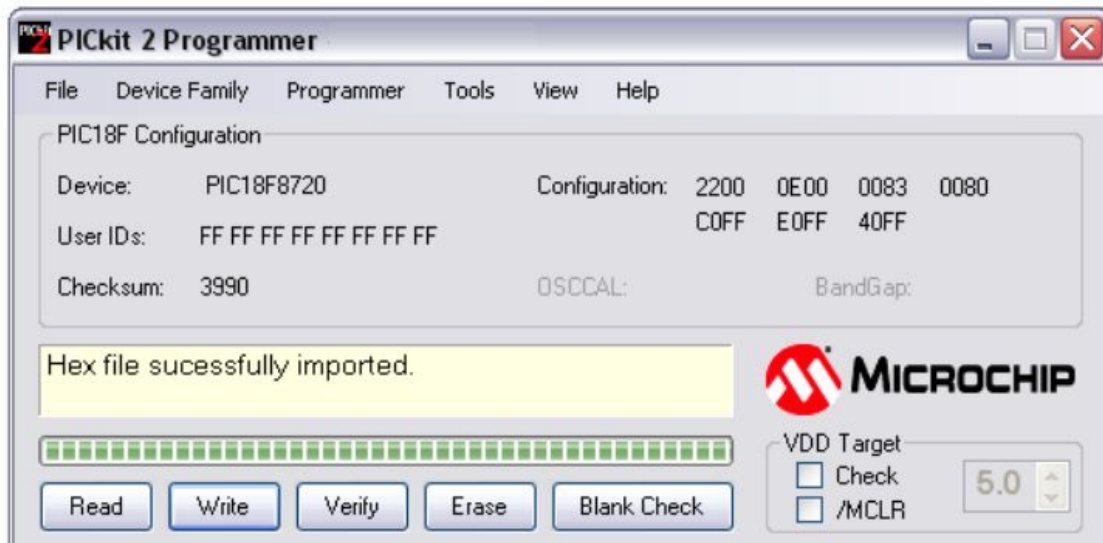

8. The status of the write operation is displayed in the status bar located under the device Configuration window. If the write is successful, the status bar turns green and displays "Programming Successful" as shown in figure below.

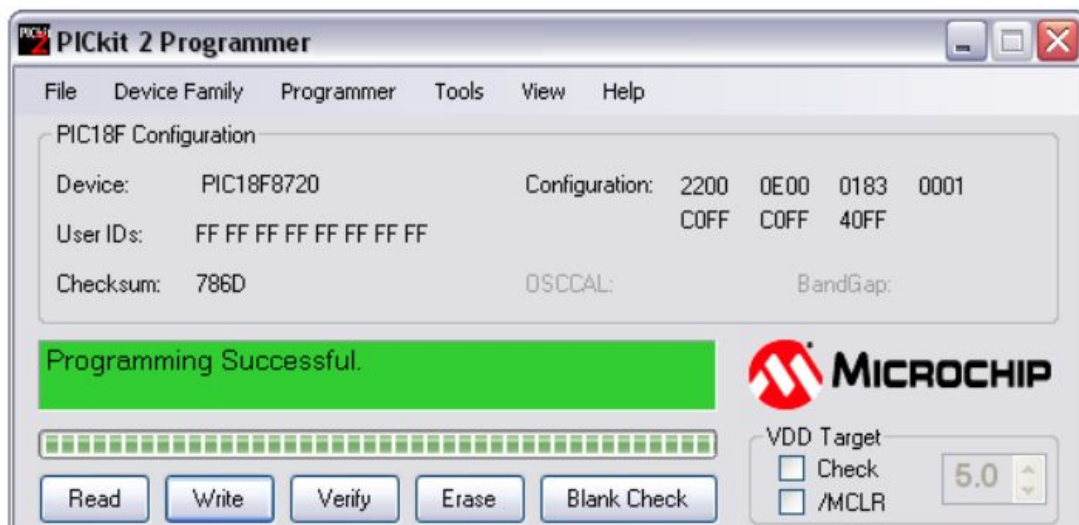

9. User may automatically reload hex file using push button (on UIC00B main board). Push button can be used after *Programmer>Write on PICKit Button* is checked as figure below:

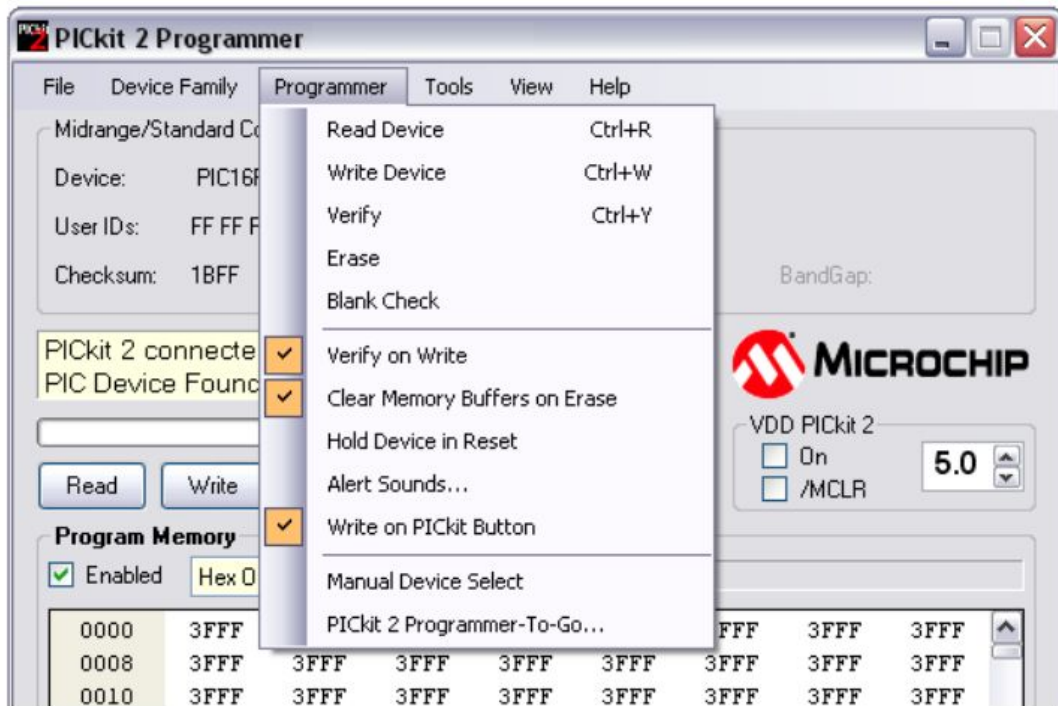

10. Push button allow user to reload the updated hex file into the target device. After convert any changes in the program into Hex file, press push button and UIC00B will automatically reload the new Hex file, further program into the target device.
11. *Verify* function verify the device program to the imported Hex file. *Read* function is to view the code written to the PIC. The code will be display in the Program Memory and Data EEPROM Memory. If all zero display, it is possible that the target device is code-protected. *Erase* button erases the program memory, data EEPROM memory, ID and Configuration bits, regardless of the state of the Program Memory and EEPROM Data “Enabled” checkboxes. *Blank Check* button will read the entire device to determine if Program Memory, EEPROM Data Memory, User Id and Configuration bits are erased.



12. *Auto Import Hex + Write Device* allows the programmer to automatically import and write the Hex file to the connected device when the Hex file is updated, for an example on a new firmware build. By clicking this icon, it will bring up an Import Hex File dialog. *Read Device + Export Hex File Button* will read the target device and open an Export Hex File dialog.



13. After selecting file, Hex code will be written to the target device and UIC00B will monitor the selected file for update. If the file is updated(after compiled),UIC00B will automatically re-imports the Hex file and writes to the target device. To disable this feature, simply click this icon again.

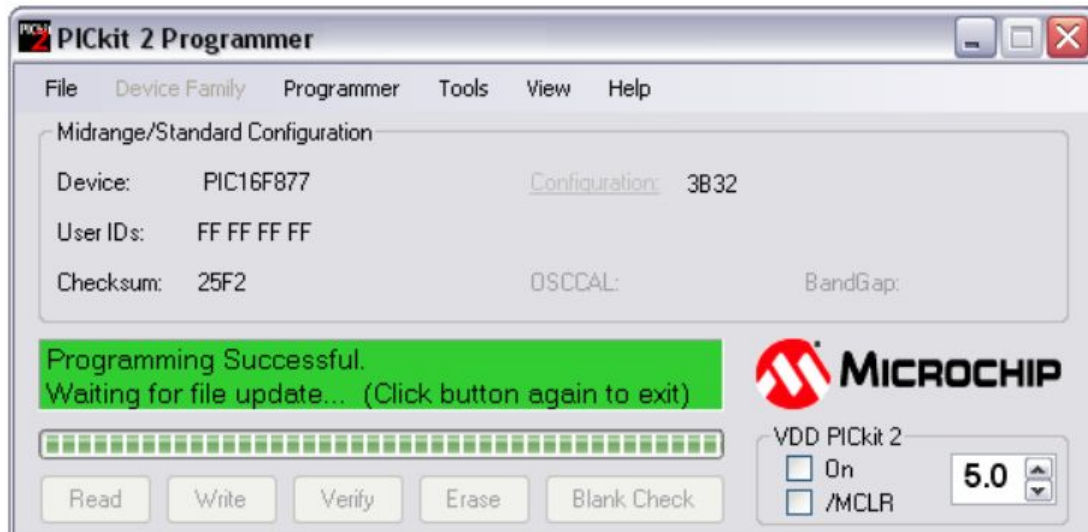

7.4 PICKit 2 UART TOOL

PICKit 2 UART Tool used as a serial UART terminal interface for communication with a PIC microcontroller. The features of PICKit 2 UART Tools are:

- Displaying debug text output from microcontroller.
- Logging microcontroller data to a text file
- Developing and debugging a microcontroller UART interface
- Interfacing with and sending commands to the microcontroller during development.

Connecting the PICKit 2 UART Tool

UIC00B connects to the target board as shown in figure below. The UIC00B Tx signal (out) should connect to the target Rx signal (in), and the UIC00B Rx signal (in) should connect to the target Tx signal (out).

No Pin	UIC00B Pin Description	Connection to Target board
1	Not connect	-
2	Not connect	-
3	Not connect	-
4	GND	GND
5	Tx	Rx
6	GND	GND
7	Rx	Tx
8	V _{DD}	V _{DD}
9	Not connect	-
10	Not connect	-

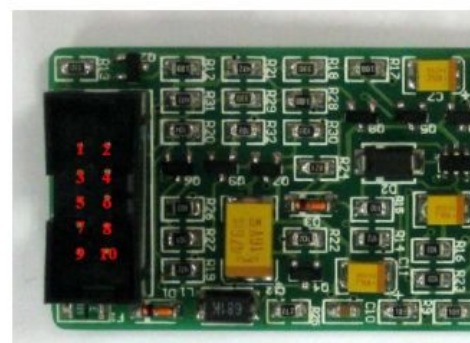

***UIC00B ICSP Programmer Pin**

*Example pin connection from UIC00B to target board for UART Logic Tool.

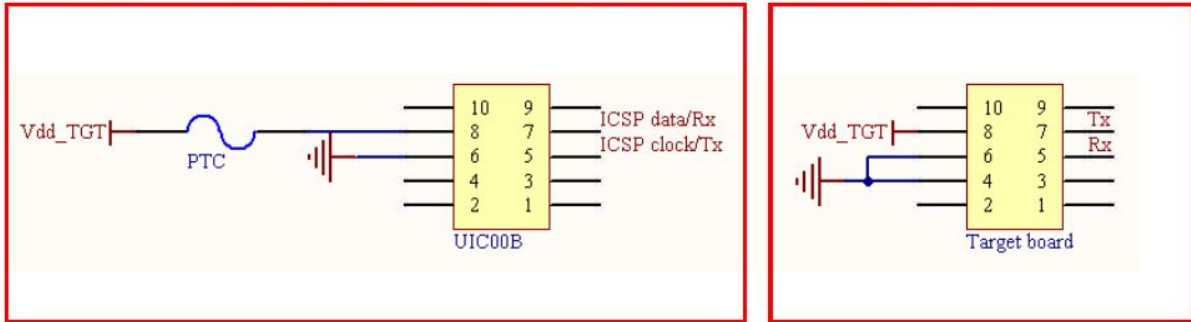

When using PICKit UART Tool, UIC00B may not be able to supply VDD voltage to the target board depending on the application version. However, even when UIC00B not supplying the target VDD, the UIC00B VDD must be connected to the target VDD voltage or it will not be able to communicate.

The UIC00B will supply target VDD from 3.3V to 5V.

PICKit 2 UART Tool Window

To start with PICKit 2 UART Tool, select Tools> UART Tool... The PICKit 2 Programmer cannot be used while the UART Tool is active. The PICKit 2 UART Tool Window shown as figure below.

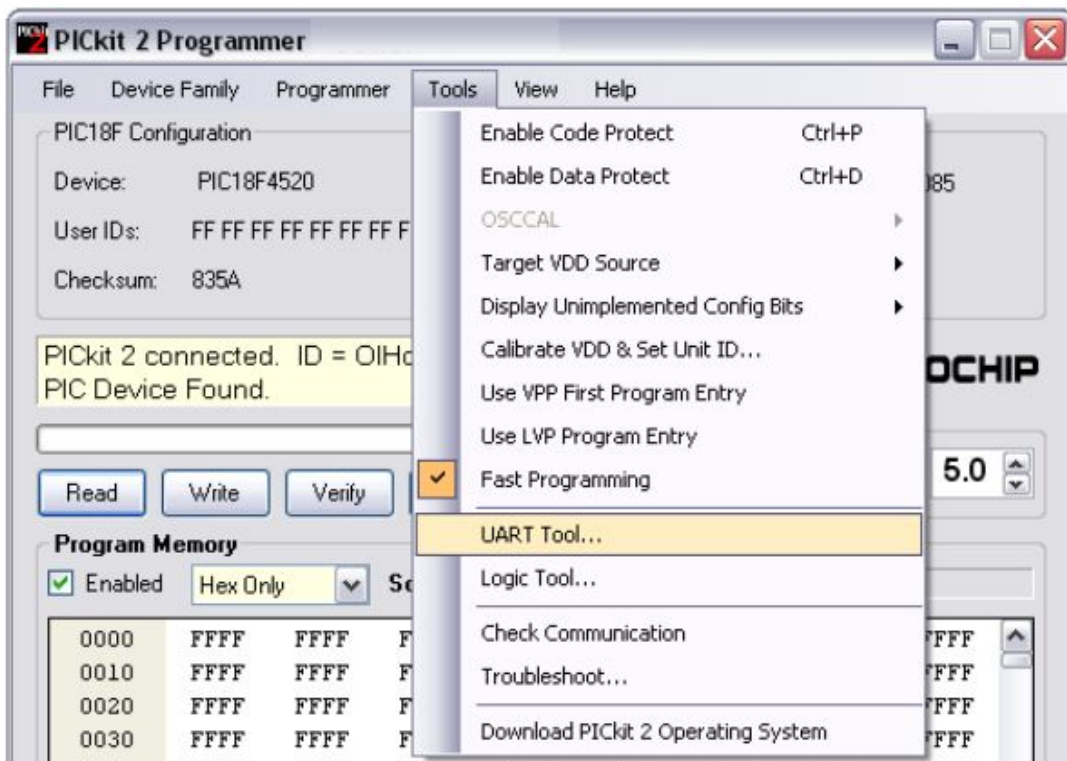

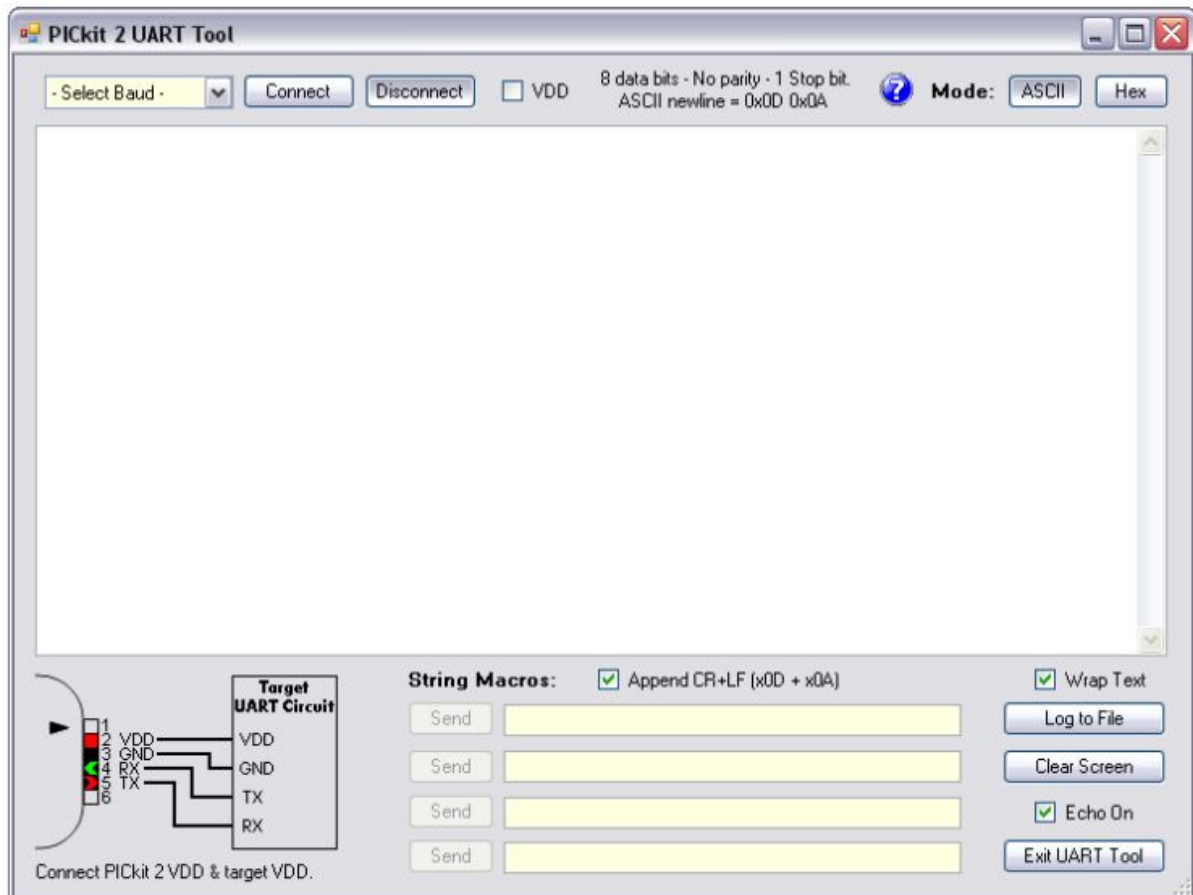

The UART Tool has 2 modes which are ASCII and HEX. The mode buttons are on the upper right hand of the display. The mode selection affects how serial data is displayed and entered in the window.

The baudrate may be selected from the combo box in the upper left corner of the UART Tool window. The baudrate can be used is between 150 to 38400.

Click **Connect** to enable the UART Tool serial interface at the selected baud. Click **Disconnect** to disabled connection.

7.4.1 ASCII Mode

When ASCII mode is selected, serial bytes received from the target's UART are displayed as ASCII characters in the main window terminal display.

Bytes may be transmitted in three ways:

- Click on the terminal display to select it. Any characters typed on the PC keyboard will be immediately transmitted out of PICKit 2.
- Right click on the terminal display and select Paste from the pop-up menu to paste any previous copied or cut text. Any pasted data will immediately be transmitted out of PICKit 2.
- Use the “String Macros” at the bottom of the window. The “String Macros” allow up to four strings of characters to be entered. Each string can be up to 60 characters long.

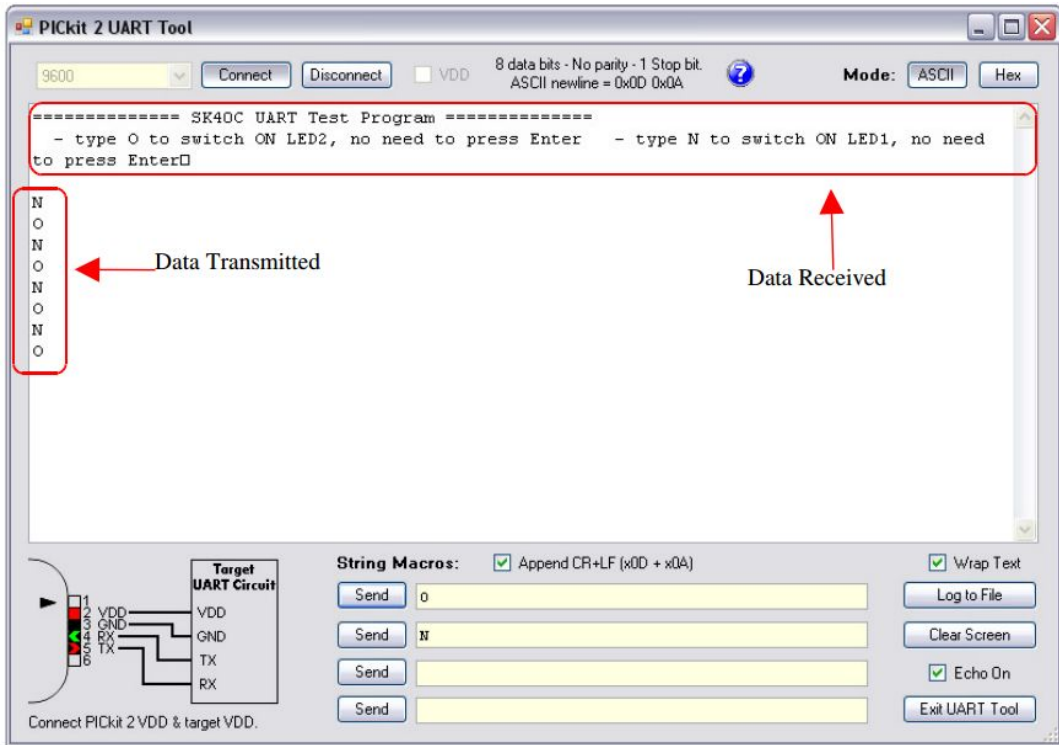

7.4.2 Hex Mode

The UART Tool Hex mode displays the hex values of bytes received from the target's UART in the terminal display.

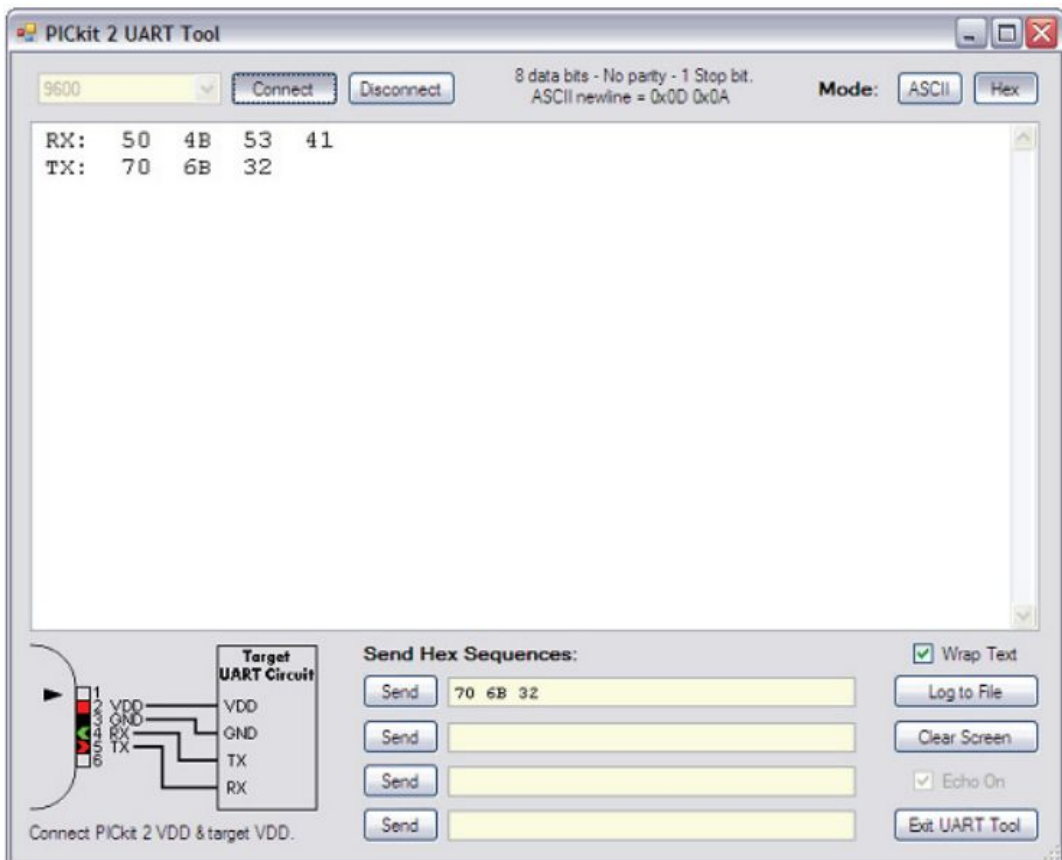

A line of bytes received by the UART Tool is preceded with the “Rx:” and a line of bytes transmitted by the UART Tool is preceded with the text “Tx:”. From Figure above, the four hex bytes 0x50, 0x4B, 0x53 and 0x41 were received from the target. The three bytes 0x70, 0x6B and 0x32 were then transmitted.

In the hex mode, bytes may only be transmitted one way: by typing a sequence of one or more hex values in one of the four “Send Hex Sequences:” boxes. To send a sequence, click Send next to it. A hex sequence may contain from 1 to 48 bytes.

7.5 PICKIT 2 LOGIC TOOL

The PICKit 2 Logic Tool will be use UIC00B ICSP™ (In Circuit Serial Programming) connector pins for stimulating and probing digital signals on a target circuit, and as a simple 3 channel logic analyzer. They are 2 logic modes in PICKit 2 Logic Tool which are

- Logic I/O mode
- Analyzer mode

To open PICKit 2 Logic Tool, select Tools> Logic Tool

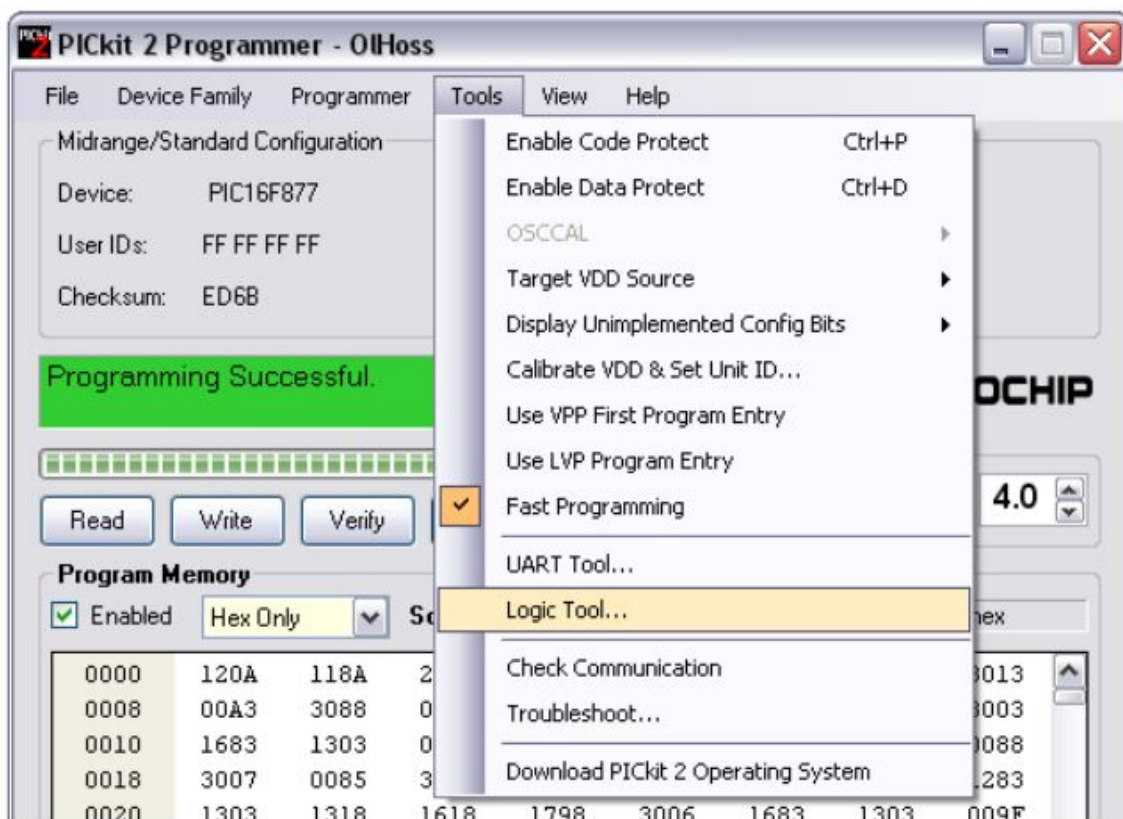

7.5.1 Logic I/O Mode

The Logic I/O mode is useful for triggering inputs to a PIC microcontroller or other digital circuitry, and monitor digital signals to display their state.

No Pin	Pin Description	Logic I/O Function
1	Not connect	-
2	Not connect	-
3	Vpp	Digital Output
4	GND	GND
5	ICSP Clock/PGC	Digital Output or Digital Input
6	GND	GND
7	ICSP Data/PGD	Digital Output or Digital Input
8	VDD	VDD
9	Aux_Out	Digital Output or Digital Input
10	Not connect	-

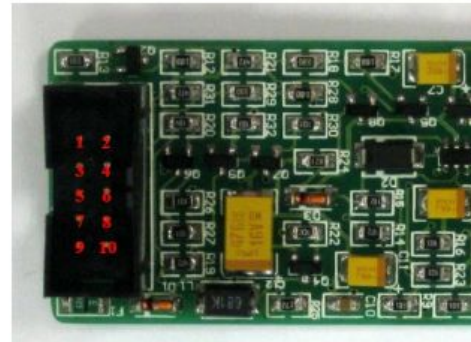

***UIC00B ICSP Programmer Pin**

***Example pin connection from UIC00B to target board for Logic I/O mode**

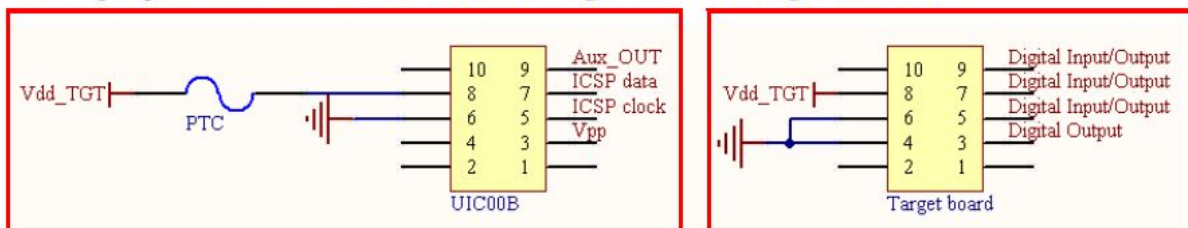

UIC00B pin must be connected to the target circuit VDD supply. The voltage level at the VDD pin sets the output high voltage for pins 5, 7, & 9 when used as outputs. For example, if using the PICkit 2 to provide digital stimulus to a 3.3V circuit, the VDD pin should be either set to or connected to a 3.3V supply to limit the output high voltage to 3.3V.

Pin 3's output voltage swing is determined by the voltage on the VDD pin when the Logic I/O is first enabled.

When used as inputs, pins 5 & 7 may be used to monitor signals down to 2.5V logic, as these are TTL input buffers. Pin 9 as an input may be used to monitor signals down to 3.6V logic. It may not reliably report high signal states for lower voltage logic signals as the input buffer is a Schmitt Trigger.

Configuring the Logic Tool Logic I/O

The PICKit 2 Logic Tool “Logic I/O” mode is the default mode when the Logic Tool is first opened.



Since the UIC00B hardware is not designed according to the PICKit2 GUI, the logic I/O shown in figure above will be different with UIC00B pin used for Logic I/O. UIC00B use pin 3,5,7,9 compare with PICKit2 which use pin 1,4,5,6 for logic I/O. Below is summarized about PICKit2 and UIC00B pin used for logic I/O. Please refer table on section 10.1 for UIC00B logic I/O pin.

<u>PICKit2</u>	<u>UIC00B</u>
Pin 1 (MCLR/Vpp) -----	Pin 3 (MCLR/Vpp)
Pin 2 (Vdd target) -----	Pin 8 (Vdd)
Pin 3 (GND) -----	Pin 4/6 (GND)
Pin 4 (ICSPDAT/PGD) -----	Pin 7 (ICSP data/PGD)
Pin 5 (ICSPCLK/PGC) -----	Pin 5 (ICSPCLK/PGC)
Pin 6 (Auxiliary) -----	Pin 9 (Aux_Out)

Click **Enabled IO** button to activate the UIC00B pins used for Logic I/O digital signals (pins 3, 5, 7, & 9). After the IO is enabled, user may configure it. If no valid voltage is detected on the VDD pin when clicking **Enabled IO** a dialog will pop up to alert the user.

Setting Pin Direction

Now that the I/O pins are enabled, the pin directions and output states can be configured.

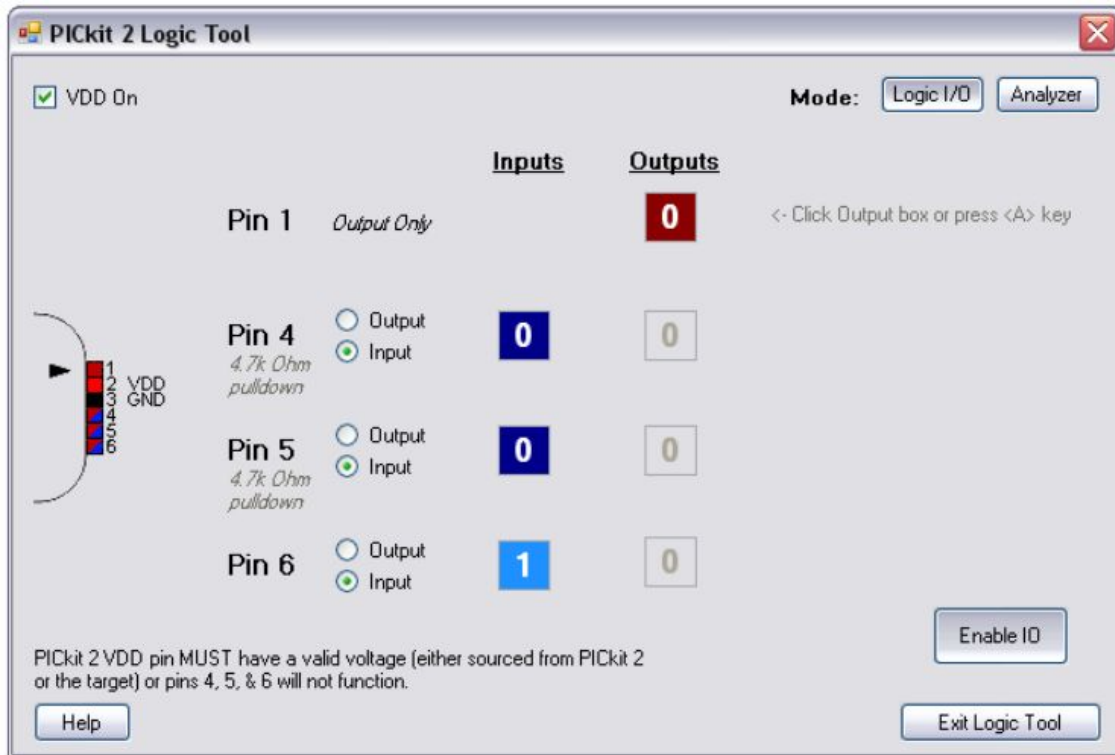

Logic I/O shown in figure above is different with UIC00B pin used for Logic I/O. UIC00B use pin 3, 5, 7 and 9 for Logic I/O. Please refer table on chapter 9.1 for Logic I/O pins.

Pins 5, 7, & 9 may be configured as Outputs (output a digital signal from UIC00B) or Inputs (monitor a digital signal state connected to the pin). Pin 3 is only available as an output.

Click the radio buttons next to the Pin# to set the pin as an Output or Input. When the pin is an Input, the connected signal state is displayed in the blue “Inputs” box as shown in Figure below.

Logic I/O Input Signal is Logic Low (0)

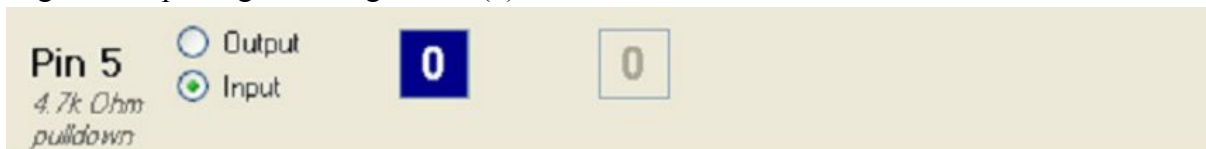

Logic I/O Input Signal is Logic High (1)

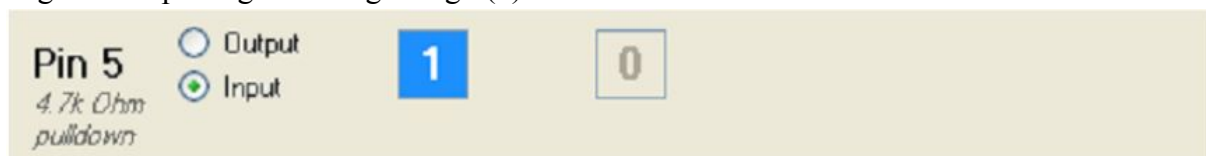

Pin 5 and pin 7 have a 4.7K Ohm pull down resistor internal to the UIC00B. This resistor is necessary for the PICkit 2 debugger functions, but note that this pull down resistor will

affect any digital signal it is connected to. Generally, it is only an issue when using Pin 5 and pin 7 as an input.

When a pin is selected as an Output, the pin will drive the logic level shown in the read “outputs” box. Toggle the output state by clicking on the Output state box.

Logic I/O Input Signal is Logic Low (0)



Logic I/O Input Signal is Logic High (1)



7.5.2 Logic Analyzer Mode

The Analyzer mode of the PICkit 2 Logic Tool enables using UIC00B as a simple channel logic analyzer to capture, view and measure the digital waveforms of up to 3 signals.

Connecting the UIC00B in Analyzer Mode

The UIC00B ICSP connector pins 5, 7, & 9 are used as the inputs for the 3 logic channels.

No Pin	Pin Description	Logic I/O Function
1	Not connect	-
2	Not connect	-
3	Vpp	-
4	GND	GND
5	ICSP Clock/PGC	Analyzer Channel 1
6	GND	GND
7	ICSP Data/PGD	Analyzer Channel 2
8	VDD	VDD
9	Aux_Out	Analyzer Channel 3
10	Not connect	-

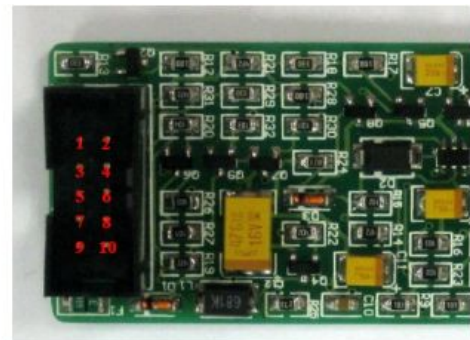

***UIC00B ICSP Programmer Pin**

***Example pin connection from UIC00B to target board for Analyzer mode**

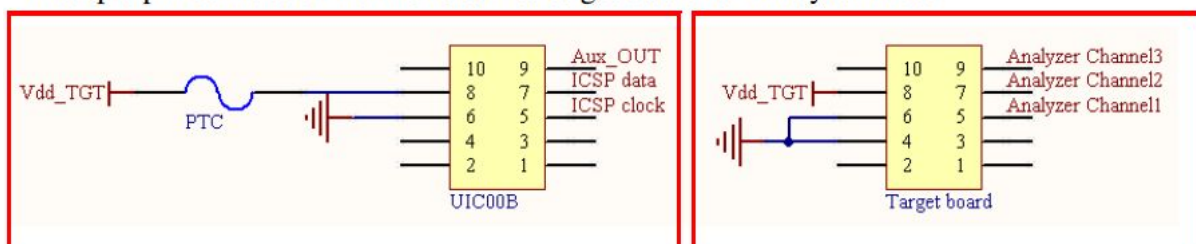

For example, to monitor a SPI bus, the analyzer channel pins could be connected to monitor the 3 main bus signals as follows:

Logic Analyzer Pin

Analyzer Channel 1
Analyzer Channel 2
Analyzer Channel 3

SPI Bus Signal

SCK
SDO (bus master output)
SDI (bus master input)

The UIC00B VDD pin must be connected to the target circuit VDD supply or set to provide a VDD output voltage in the main PICKit 2 application form.

Having the VDD pin connected is necessary as the PICKit 2 logic channel pins are clamped to the VDD pin voltage. If no voltage is present on VDD, the analyzer channel pins will be essentially clamped to ground.

It is possible to have UIC00B output a VDD voltage without connecting pin2 to the circuit VDD, as long as the VDD level is greater than or equal to the target circuit logic high voltage.

Channels 1 & 2 (pins 5 and 7) may be used to monitor signals down to 2.5V logic, as these are TTL input buffers. Channel 3 (pin 9) may be used to monitor signals down to 3.6V logic. It may not reliably report high signal states for lower voltage logic signals as the input buffer is a Schmitt Trigger.

The Logic Analyzer Window

The Logic Tool analyzer window is shown as figure XX below.

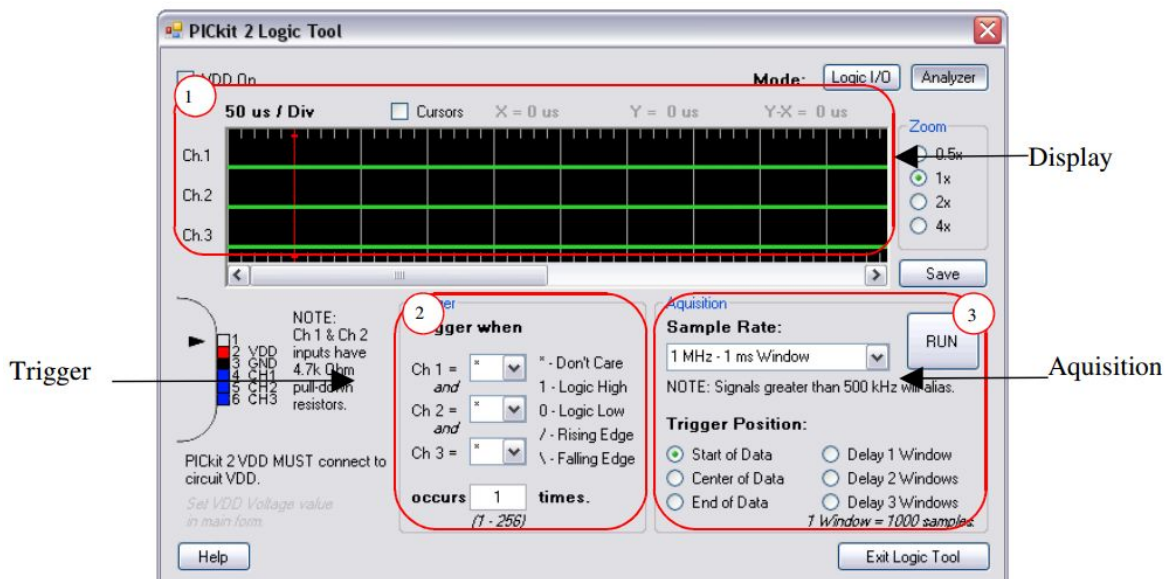

The Logic Tool analyzer is divided into 3 sections which are

1. Display – for viewing and measuring captured waveforms.
2. Trigger – for setting trigger conditions for a capture.
3. Acquisition – for setting the waveform sample rate and the waveform relation to the trigger sample.

The Analyzer Display section

The display section of the analyzer window allows the waveform to be viewed, zoomed, measured, and saved as a bitmap file.

Figure below shows a SPI bus waveform capture of a 2-byte transmission, and details the elements of the display window section.

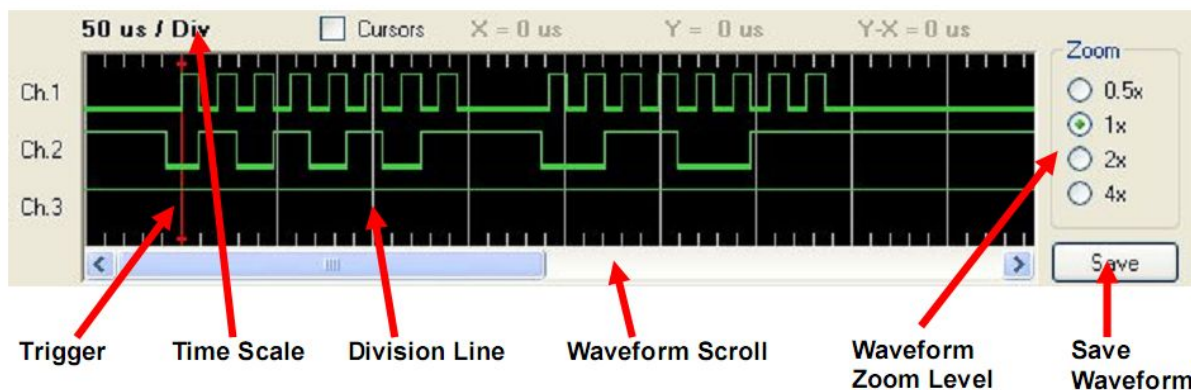

The Analyzer Trigger section

The “trigger” is a user-defined set of events in the monitored signals that causes the capture of a waveform.

Each channel can be assigned one of the following trigger events:

Trigger Events

'*' (Don't care)	The analyzer channel is ignored for triggering purposes
'1' (Logic High)	The channel must be at a logic high state to trigger
'0' (Logic Low)	The channel must be at a logic state to trigger
'/' (Rising Edge)	The channel must transition from low to high states to trigger
'\' (Falling Edge)	The channel must transition from high to low states to trigger

All trigger events on all channels must happen at once in order for the trigger to activate data capture. For example, for Figure 1-1, the trigger was set to simply detect the first rising edge on channel 1:

Figure 1-1 Trigger Conditions

Ch 1 = / (rising edge)
Ch 2 = * (ignore)
Ch 3 = * (ignore)

If the trigger conditions are changed as follows, where both a rising edge must be detected on channel 1 at the same time channel 2 is at a logic high state, the trigger will happen on the second clock instead as shown in Figure 1-2. During first clock's rising edge, channel 2 is logic low, so this does not fully satisfy the trigger condition.

Figure 1-2 Trigger Conditions

Ch 1 = / (rising edge)

Ch 2 = 1 (logic high)

Ch 3 = * (ignore)

Figure 1-2 Trigger Ch 1 Rising Edge when Ch 2 is high

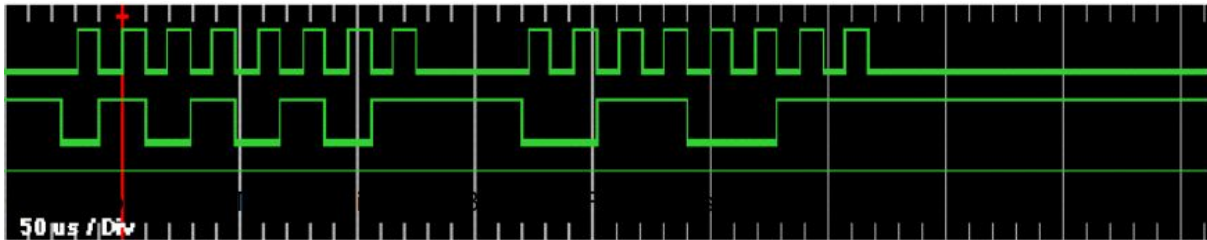

The Analyzer Acquisition Section

The “Acquisition” section of the analyzer window is used to set the waveform sample rate, the position of the trigger relative to the captured waveform, and to start or “run” the analyzer.

Acquisition Settings

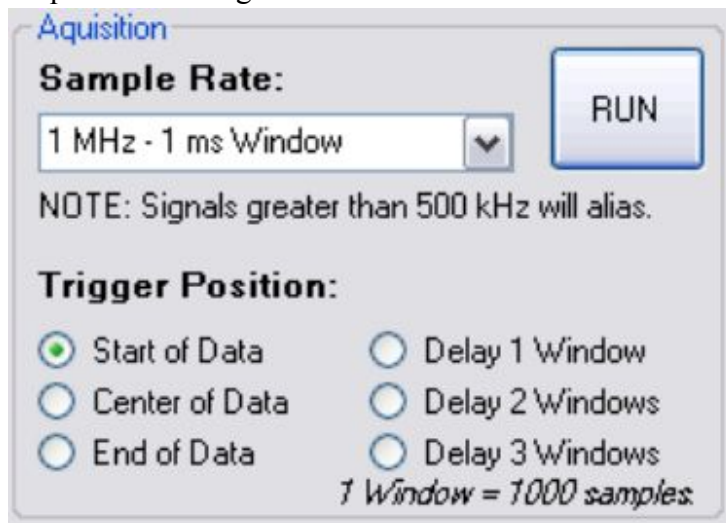

Sample Rate

The sample rate is how often the analyzer channels are look at. Each waveform capture is only 1024 samples long, so if we want to look at a longer period of time in the waveform display, we have to sample less often.

Trigger Position

Changing the trigger position allows more flexibility over how the captured data relates to the trigger event. For example, we might be more interested in what happened before the trigger, rather than after.

Delay Window

When “Delay 1 window” is selected, the analyzer will wait 1000 samples after the trigger event occurs before it begins recording waveform data. When “Delay 2 Windows” is selected, it will wait 2000 samples etc.

Running the Analyzer

Once the trigger conditions, sample rate, and trigger position are set as desired click the RUN button to begin collection waveform data and looking for trigger events.

When the analyzer is running, it will show the dialog in figure below.

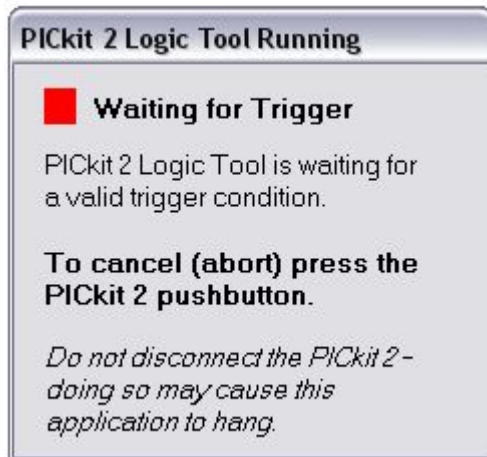

8. GETTING STARTED

UIC00B can be used in two methods:

1. Program a PIC MCU with the MCU on development board which has been shown in section **6.1**.
2. Program a PIC MCU in standalone mode, shown in section **6.2**.

8.1 Using UIC00B with application circuit (development board)

UIC00B can program PIC microcontroller installed in the application circuit using In-Circuit Serial Programming (ICSP). In-Circuit Serial Programming requires five signals:

- V_{PP} – Programming voltage. When applied, the device goes into programming mode.
- ICSPCLK/PGC/RB6 – Programming clock; a unidirectional synchronous serial clock line from the programmer to the target.
- ICSPDAT/PGD/RB7 – Programming data; a bidirectional synchronous serial data line.
- V_{DD} (3.3V/5V) – Power supply positive voltage, it can be either from programmer or application circuit. This is optional to target PIC. If target PIC is powered externally (recommended) this pin should **NOT** be connected to target PIC.
- V_{SS} (Gnd) – Power supply ground reference.

However, the application circuit must be designed to allow all programming signals (V_{pp} , ICSPCLK/PGC/RB6 and ICSPDAT/PGD/RB7) to connect to the PIC microcontroller device without distorting the programming signals.

Figure below shows a typical circuit as a starting point when designing an application circuit for the ICSP. Those unconnected pins (1, 2, 9 & 10) of Box header should be **leaved unconnected** on application circuit. Figure below is the example for +5V PIC:

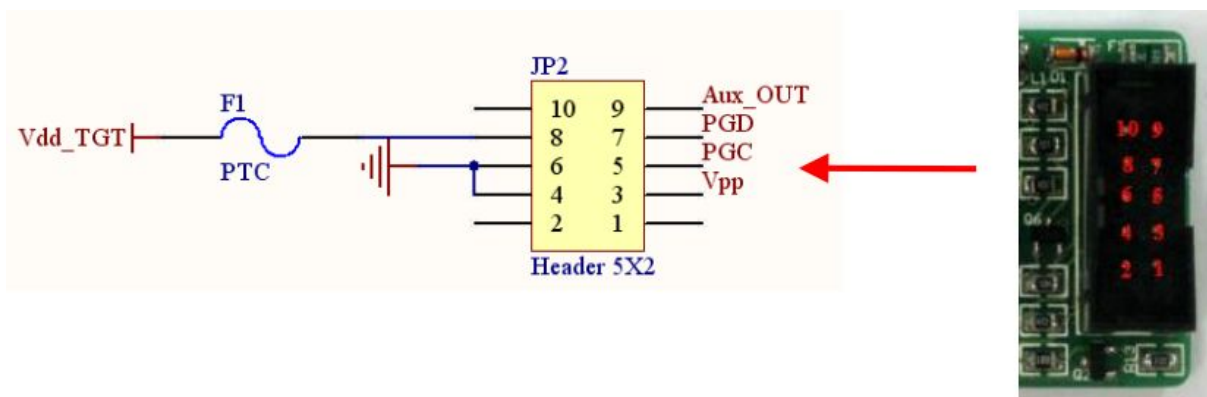
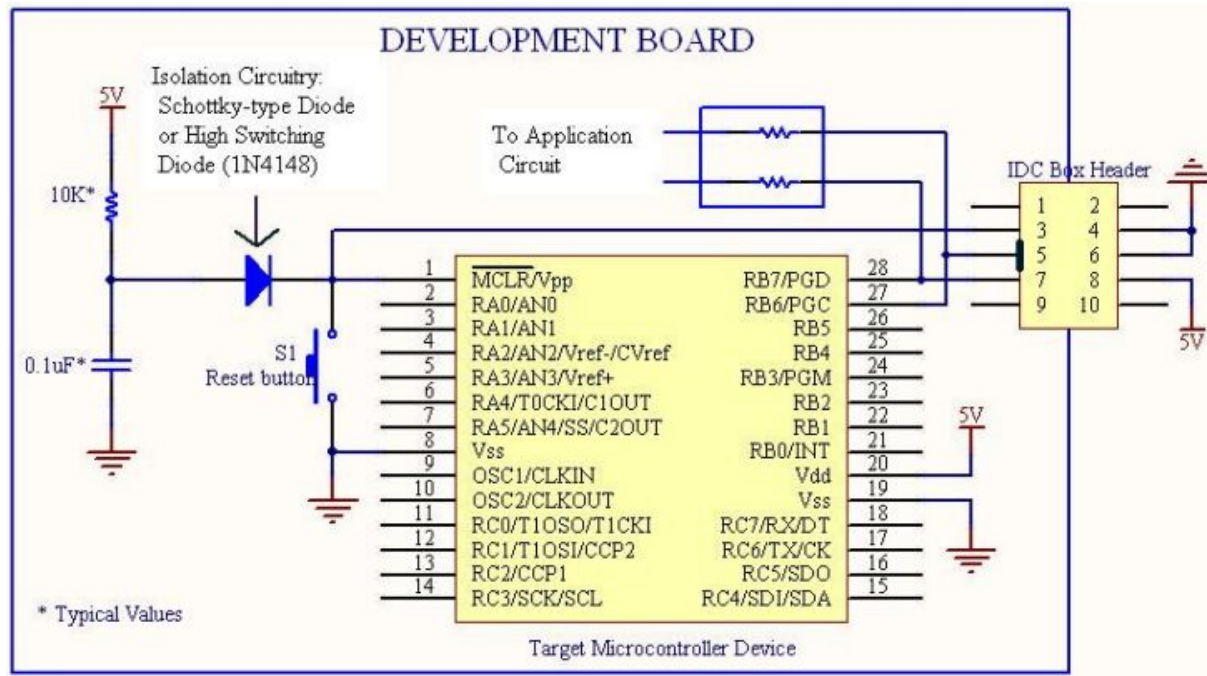

Note: PIC microcontroller in the figure above is for reference purpose only. Refer to PICKit 2 Readme for supported PIC models.

Please be aware of:

- During programming mode, it is recommended to isolate the supervisory circuit if interfaces with MCLR pin by using Schottky-type diode or high switching diode (1N4148) to prevent V_{pp} voltage slew rate from slow down and exceeds the rise time in the programming specification (typically $1\mu s$). There should **not** be capacitive component (capacitor) connected to MCLR **directly**.
- RB7/PGD or RB6/PGC pin are recommended to use as output controlling non critical device such as LED, LCD, 7 segments or buzzer. It is recommended to isolated ICSP signals from application circuit by using series resistor (range 220 ohm and above) as shown in figure above. Furthermore, **NO** capacitive component (capacitor) should be connected to these 2 pins directly.

- During ICSP programming, PIC microcontroller needs to be powered. It is recommended to power the target externally; USB is not able to support large power usage. If target PIC is powered externally V_{DD} (3.3V/5V) should **NOT** be connected to target PIC.
- The **minimum connections** from UIC00B to target board or PIC are **four**. These include **Vpp, PGD, PGC** and **Vss (Gnd)**.
- Thus, the 3.3V/5V from UIC00B is an **optional connection**. If user is powering up the target board with external power, this pin is not necessary to connect from UIC00B to target board.
- For usage example, please refer to DIY Project (PR7 onwards) in Cytron website.

8.2 Using UIC00B with UIC-S (optional, buy separately)

UIC-S is an optional socket that can be used with UIC00B to program several types of PIC microcontroller. Below are the steps of using the UIC-S and method to connect it to UIC00B:

1. Connect one side of the rainbow cable (programming cable) to box header of UIC00B board and the other side to box header of UIC-S as shown in section 6.2. Power LED will not turn on at this time.
2. After that, use mini jumper (on UIC-S) to select either 18 pins or 28/40 pins (according to the PIC microcontroller that you want to program).
3. Load the hex file as shown in section 8. LED PWR of UIC-S will ON (once user click write button to load the hex file) indicate that the board is working correctly.

9. TROUBLESHOOTING

Following section discuss error messages from PICKit 2 programming software, possible root causes and methods to fix it.

1. Window (right bottom corner) show “Unrecognized USB device” when UIC00B is connected to USB port.
 - Please check the connection of your USB cable (computer and also UIC00B).
 - Please try to use other USB cable.
 - Please try other USB port on computer.
 - Please try on other computer.
 - If the problem still occur, please contact Cytron at support@cytron.com.my
2. Status Window shows: “PICKit 2 not found. Check USB connections and use Tools->Check Communication to retry”.
 - Please reconnect the UIC00B to USB port and try again.
 - Driver might not be installed properly, uninstall driver and install again.
 - User might need to update Operating System. Please refer to step 14 of chapter 7.
 - Check the power LED on UIC00B. If it is Off, UIC00B have hardware problem.
3. Status Window shows: “No device detected” while Device shows: “No Device Found”.
 - Please ensure the target PIC is powered with typical voltage of 5V for Vcc.
 - Please ensure the **PGC and PCD** is connected to correct pin on target PIC.
 - Please ensure the Vss (Gnd) of UIC00B and target PIC is common (connected).
4. Device shows: “Unsupported part”.
 - Please ensure the Vss (Gnd) of target PIC is connected.
 - Please ensure the target PIC is in supported list.
5. A small message window shows: “PICKit 2 VPP voltage level error. Check target & retry operation”.



- Check MCLR pin of target PIC, it must **not** pulled to ground during programming.
- Check MCLR pin of target PIC, there should not be capacitor connected.

For any feedbacks and inquiries, please send an email to support@cytron.com.my

10. WARRANTY

- Product warranty is valid for 12 months.
- Warranty only applies to manufacturing defect.
- Damaged caused by misuse is not covered under warranty
- Warranty does not cover freight cost for both ways.

Prepared by:

Cytron Technologies Sdn. Bhd.

No. 16, Jalan Industri Ringan Permatang Tinggi 2,
Kawasan Industri Ringan Permatang Tinggi,
14100 Simpang Ampat,
Penang, Malaysia.

Tel: +604 - 504 1878

Fax: +604 - 504 0138

URL: www.cytron.com.my

Email: support@cytron.com.my

sales@cytron.com.my